

# 50m XHD & 60m XHD TallTower™ Installation

USER'S MANUAL



**NRG**Systems™

110 Riggs Road  
Hinesburg, VT 05462 USA  
support@nrgsystems.com  
+1 802.482.2255 | nrgsystems.com



# Table of Contents

**Chapter 1: Safety Considerations ..... 6**

1.1 WARNINGS  ..... 6

1.3 SAFETY BULLETIN FOR TOWER INSTALLATIONS IN AGRICULTURAL AREAS OR REMOTE AREAS WHERE  
LOW FLYING AIRCRAFT OPERATE ..... 9

**1.4 Tower Obstruction Marking ..... 10**

1.5 References ..... 11

**Chapter 2: Pre-Installation Guidelines ..... 11**

2.1 TallTower History ..... 11

2.2 Construction and Assembly ..... 11

2.3 Required Parts to Erect Tower System ..... 11

2.4 Experience Required ..... 12

Previous experience installing other TallTowers is required for successful installation of 60 and 50 meter  
XHD TallTowers. If you have no prior experience with TallTower installation, seek assistance from a qualified  
installer. 2.5 Using This Manual ..... 12

2.6 Tools Required For Various Tasks But Not Supplied ..... 12

2.7 Recommendation:..... 13

2.8 Unpack your tower ..... 13

2.9 Site Layout..... 18

    Tip: Cellular Coverage..... 18

2.10 Site Layout Map ..... 18

**Chapter 3: Tower Assembly ..... 20**

3.1 Assemble the Baseplate ..... 20

3.2 Install the Anchors ..... 26

3.3 Tube Layout..... 26

    SI Units..... 27

    Imperial Units ..... 28

3.4 Install the Tower Base Tube ..... 29

3.6 Tower Pre-lift ..... 31

3.7 Attach sensors and booms..... 31

**3.8 Attach the Guy Wires ..... 34**

3.9 Assemble the Ginpole ..... 37

3.10 Set up the Winch Cable..... 43

3.10.2 Option of using the NRG Systems 80 meter winch to raise the 60m XHD TallTower..... 45

**Chapter 4: Installation Process..... 46**

4.1 Ginpole Tilt-Up ..... 46



4.4 Lift the Tower .....	51
4.4.2 Back Guy Wire Tension .....	52
4.4.3 Use of Back Stay Tension System while raising the 60m XHD TallTower. ....	53
4.6 Transfer Lifters .....	54
4.7 Plumb and Straighten .....	57
4.8 Guy Tension Check .....	57
Table 4-4: Guy Tensioning per the Pulse Method (During Tower Erection) N=1 Pulse .....	59
4.9 Final Inspection and Maintenance .....	62
<b>4.10 Snap Through.....</b>	<b>63</b>
.....	<b>64</b>
4.11 Tower Lowering .....	65
<b>Appendix A: Tower Selection .....</b>	<b>66</b>
<b>Appendix B: 60m XHD with Standard Footprint .....</b>	<b>68</b>
Tower Layout .....	69
Site Layout.....	70
Code Compliance Curve – Imperial Units .....	71
Code Compliance Curve – SI Units .....	72
Stamped Drawing.....	73
Anchor Loads – Imperial Units .....	74
Baseplate Loads – SI Units .....	77
Tower Erection Forces (tower only).....	78
Tower Erection Forces (with typical NOW System – 2 booms at 40 m, 3 booms at 50 m, 3 booms at 58 m, cables) .....	78
Baseplate Geometry .....	79
<b>Appendix D: 60 m XHD with Small Footprint .....</b>	<b>86</b>
Tower Layout .....	87
.....	87
Site Layout.....	88
Code Compliance Curve – Imperial Units .....	89
Code Compliance Curve – SI Units .....	90
Anchor Loads – Imperial Units .....	91
Anchor Loads – SI Units.....	92
Baseplate Loads – Imperial Units .....	93
Tower Erection Forces (tower only).....	95
Tower Erection Forces (with typical NOW System – 2 booms at 40 m, 3 booms at 50 m, 3 booms at 58 m, cables) .....	95
Baseplate Geometry .....	96
<b>Appendix E: 60m XHD with Single Anchor .....</b>	<b>98</b>
Tower Layout .....	98



Site Layout.....	100
Code Compliance Curve – Imperial Units .....	101
Code Compliance Curve – SI Units .....	102
Anchor Loads – Imperial Units (The loads shown on the graph apply to each of the anchors) .....	103
Baseplate Load – Imperial Units .....	105
Baseplate Load – SI Units .....	106
Tower Erection Forces (tower only).....	107
Tower Erection Forces (with typical NOW System – 2 booms at 40 m, 3 booms at 50 m, 3 booms at 58 m, cables) .....	107
Baseplate Geometry .....	108
<b>Appendix F: 50m XHD with Standard Footprint .....</b>	<b>110</b>
Tower Layout .....	110
Site Layout.....	112
Code Compliance Curve – Imperial Units .....	113
Code Compliance Curve - SI Units.....	114
Anchor Loads – Imperial Units (The loads shown on the graph apply to each of the anchors) .....	115
Anchor Loads – SI Units (The loads shown on the graph apply to each of the anchors).....	116
Baseplate Loads – Imperial Units .....	117
Baseplate Loads – SI Units .....	118
Tower Erection Forces (tower only).....	119
Tower Erection Forces (with typical NOW System – 2 booms at 30 m, 3 booms at 40 m, 3 booms at 50 m, cables) .....	119
<b>Appendix G: 50m XHD with Small Footprint .....</b>	<b>122</b>
Site Layout.....	124
Code Compliance Curve – Imperial Units .....	125
Code Compliance Curve – SI Units .....	126
Stamped Drawing.....	127
Anchor Loads – Imperial Units .....	128
Anchor Loads – SI Units (The loads shown on the graph apply to each of the anchors).....	129
Baseplate Loads – Imperial Units .....	130
Baseplate Loads – SI Units .....	131
Tower Erection Forces (tower only).....	132
Tower Erection Forces (with typical NOW System – 2 booms at 30 m, 3 booms at 40 m, 3 booms at 50 m, cables) .....	132
Baseplate Geometry .....	133
<b>Appendix H: Lightning Protection and United States FAA Height Compliance.....</b>	<b>135</b>
Instructions .....	136
<b>Appendix I: Anchoring Guidelines .....</b>	<b>138</b>
Determine site soil and anchor type before you order your tower .....	138
Anchor Choices and other considerations .....	138
Screw-In Anchor description .....	139
Arrowhead Anchor description .....	141



Rock Anchor description .....	142
Concrete Anchor description.....	142
Installing Screw-In Anchors.....	143
Installing Arrowhead Anchors.....	143
Installing Rock Anchors .....	145
<b>Appendix J: Choosing a Winch and Ginpole .....</b>	<b>146</b>
<b>Appendix K: Structural Analysis .....</b>	<b>147</b>
<b>Appendix L: Site Visit Procedures .....</b>	<b>154</b>
Site Checklist .....	154
<b>Appendix M: Glossary .....</b>	<b>155</b>
<b>Appendix N: Hankmaster Tool for Unrolling Guy Wires .....</b>	<b>167</b>
<b>Appendix O: 60m XHD TallTower Painted Version .....</b>	<b>170</b>
<b>Appendix P: 50m XHD TallTower Painted Version .....</b>	<b>171</b>
<b>Appendix Q: 2.4 m (95”) Side Mount Boom Installation.....</b>	<b>172</b>
Introduction.....	172
Installation.....	172
<b>Appendix R: NRG 60m XHD TallTower Back Guywire Tensioner Assembly and Operating Instructions</b>	<b>176</b>
R.1 Introduction .....	176
R.2 Back Guywire Tensioner System Overview .....	176
R.3 Back Guywire Tension Assembly .....	178
R.4 60m XHD Tower Lift .....	180
R.4.1 Phase 1: Tower Lift from 0° to 70° .....	181
R.4.2 Phase 2: Tower Lift from 70° to 90° .....	181
R.4.3 Lift-Cycle Instructions.....	183
R.4.4 Attach the Front Guys .....	186
R.4.5 Plumb and Straighten Tower.....	186
R.5 Lowering the tower.....	187
<b>Appendix S: Utilizing the NRG Systems 80m XHD winch and HPU to raise a 60m XHD tower. ....</b>	<b>188</b>
R.1 Winch Equipment .....	188
S.2 Anchor the winch .....	192
S.4 Set-up (Reeve) the Winch Cable .....	194



## Chapter 1: Safety Considerations

### 1.1 WARNINGS



#### ALWAYS DO THE FOLLOWING:

- Only install or remove TallTowers using experienced installation crew members who are familiar with all TallTower components and safe installation and removal procedures.
- Always follow all instructions and warnings in the TallTower Installation Manual, as well as all other technical information necessary for the safe installation in a specific location.
- Always consult with appropriate professionals to determine soil type at the installation site and then the most appropriate anchor system for use at that site. Follow all anchor manufacturers' instructions.
- Always stand to the side of any guy wire under tension so that you are not in the path of a guy wire that breaks or comes loose.
- Always consult with appropriate authorities (*e.g.*, the Federal Aviation Administration, local building or zoning departments, etc.) and surrounding land owners if a TallTower is being installed in an agricultural area to determine installation and tower marking requirements so as to minimize risk to low flying agricultural aircraft.





#### NEVER DO THE FOLLOWING:

- Never begin an installation with an inexperienced or untrained installation crew.
- Never allow installation crew members to commence work unless and until each crew member has thoroughly read and understands the information contained in the TallTower Installation Manual.
- Never stand in a direct line with any guy wire under tension as it could cause serious injury or death if it breaks or comes loose.
- Never climb a TallTower.
- Never erect a TallTower in an area where electrical power lines pose a hazard.
- Never allow unauthorized persons in the area where a TallTower is being installed.
- Never begin or continue a TallTower installation during high winds.
- Never begin or continue a TallTower installation during an electrical storm or when one is imminent.
- Never use parts for one TallTower to create a shorter TallTower; this cannot be done safely.









## 1.2 SAFETY CONSIDERATIONS: ANSI Z535.5



<b>Critical Installation Step</b>	A step in the installation process that must be completed correctly. Failure to follow critical installation steps precisely may result in catastrophic failure of the ginpole or tower and endanger the lives of crew members.
	Attention: Very important step. Please read closely and follow directions.
	Warning: Indicate[s] a hazardous situation which, if not avoided, could result in death or serious injury. WARNING [signs] should not be used for property damage hazards unless personal injury risk appropriate to this level is also involved.
	Danger: Indicate[s] a hazardous situation which, if not avoided, will result in death or serious injury. The signal word "DANGER" is to be limited to the most extreme situations. DANGER [signs] should not be used for property damage hazards unless personal injury risk appropriate to these levels is also involved
	Caution: Indicate[s] a hazardous situation which, if not avoided, could result in minor or moderate injury. CAUTION [signs] without a safety alert symbol may be used to alert against unsafe practices that can result in property damage only.
	Notice: [this header is] preferred to address practices not related to personal injury. The safety alert symbol shall not be used with this signal word. As an alternative to "NOTICE" the word "CAUTION" without the safety alert symbol may be used to indicate a message not related to personal injury.



	READ ALL INSTRUCTIONS AND WARNINGS BEFORE BEGINNING ANY TOWER INSTALLATION. TOWER COMPONENTS CONSIST OF HEAVY OBJECTS OFTEN UNDER SIGNIFICANT TENSION AND SERIOUS INJURY OR DEATH CAN OCCUR IF EXTREME CAUTION IS NOT USED DURING EVERY ASPECT OF THE INSTALLATION. EVERY INSTALLATION CREW MEMBER SHOULD CAREFULLY READ AND UNDERSTAND ALL WARNINGS, INSTRUCTIONS AND OTHER INFORMATION IN THIS INSTALLATION MANUAL, INCLUDING THE GLOSSARY OF TERMS.
 <b>WARNING</b>	ONLY EXPERIENCED INSTALLERS SHOULD PERFORM TALLTOWER INSTALLATIONS. DO NOT ATTEMPT TO INSTALL A TALLTOWER IF YOU ARE INEXPERIENCED OR UNTRAINED. TALL, GUYED TOWERS AND THEIR COMPONENTS CAN POSE DANGERS THAT CAN LEAD TO SERIOUS INJURY OR DEATH TO YOU OR OTHERS AROUND YOU. DO NOT BEGIN A TALLTOWER INSTALLATION UNLESS YOU HAVE ASSEMBLED AN EXPERIENCED AND QUALIFIED CREW.
 <b>WARNING</b>	USE ONLY SUITABLE TOWER ANCHORS FOR THE SOIL TYPE AT THE INSTALLATION SITE. STABILITY OF THE COMPLETED TOWER UNDER VARYING CONDITIONS ( <i>E.G.</i> , HIGH WINDS AND ICE), AND STABILITY DURING INSTALLATION, DEPENDS ON THE USE OF PROPER ANCHORS FOR THE SOIL TYPE AT THE INSTALLATION SITE. FAILURE TO USE PROPER ANCHORS COULD CAUSE THE TOWER TO FALL RESULTING IN SERIOUS INJURY OR DEATH OR PROPERTY DAMAGE. CONSULT WITH THE APPROPRIATE PROFESSIONALS TO FIRST DETERMINE SOIL CONDITIONS AND THEN SELECT THE PROPER ANCHOR SYSTEM BEING SURE TO FOLLOW ALL ANCHOR MANUFACTURERS' INSTRUCTIONS.
 <b>DANGER</b>	DO NOT INSTALL A TALLTOWER NEAR ELECTRICAL POWER LINES. METAL TALLTOWER COMPONENTS EFFICIENTLY CONDUCT ELECTRICAL CURRENT AND CAN RESULT IN SERIOUS INJURY OR DEATH IF THEY COME IN CONTACT WITH HIGH VOLTAGE ELECTRICAL LINES. SURVEY THE PROPOSED INSTALLATION SITE AND DO NOT BEGIN ANY TALLTOWER INSTALLATION IF ANY ELECTRICAL LINES ARE PRESENT.
 <b>DANGER</b>	DO NOT BEGIN OR CONTINUE A TALLTOWER INSTALLATION DURING AN ELECTRICAL STORM. IF LIGHTNING STRIKES A TALLTOWER OR ITS METAL COMPONENTS, SERIOUS INJURY OR DEATH COULD OCCUR TO THOSE WORKING WITH OR AROUND IT. DO NOT BEGIN AN INSTALLATION, OR CONTINUE ONE, DURING AN ELECTRICAL STORM OR IF ONE IS IMMINENT.





	<p>WEAR APPROPRIATE PROTECTIVE GEAR AND USE CAUTION WHEN UNPACKING TALLTOWER COMPONENTS. WEAR GLOVES AND EYE WEAR APPROPRIATE PROTECTIVE GEAR AND USE CAUTION WHEN UNPACKING TALLTOWER COMPONENTS. WEAR GLOVES AND EYE PROTECTION WHILE UNPACKING THE ENVIROCRATE TO PREVENT CUTS AND OTHER INJURIES FROM BANDS AND SHARP OBJECTS. HEAVY COMPONENTS CAN SHIFT IF NOT UNPACKED CAREFULLY AND IN THE PROPER SEQUENCE. FOLLOW ALL UNPACKING INSTRUCTIONS.</p>
	<p>CARELESSNESS DURING TOWER INSTALLATION CAN CAUSE SERIOUS INJURY OR DEATH. AN IMPROPERLY INSTALLED TALLTOWER CAN ALSO CAUSE SERIOUS INJURY OR DEATH. FOR YOUR SAFETY AND THE SAFETY OF OTHERS ON THE INSTALLATION CREW, AS WELL AS THOSE IN THE VICINITY OF A COMPLETED TOWER:</p>

### 1.3 SAFETY BULLETIN FOR TOWER INSTALLATIONS IN AGRICULTURAL AREAS OR REMOTE AREAS WHERE LOW FLYING AIRCRAFT OPERATE



**ALWAYS USE VISIBILITY ENHANCING DEVICES ON TALLTOWERS INSTALLED IN AGRICULTURAL AREAS WHERE LOW FLYING AIRCRAFT OPERATE. THE INSTALLATION OF TALLTOWERS IN AGRICULTURAL AREAS CAN POSE A SERIOUS RISK TO LOW-FLYING AIRCRAFT. **PHYSICAL CONTACT BETWEEN AN AGRICULTURAL AIRCRAFT AND ANY PART OF A TALLTOWER OR ITS GUY WIRE SYSTEM CAN RESULT IN SERIOUS INJURY OR DEATH.** IT IS THEREFORE IMPERATIVE THAT LANDOWNERS, DEVELOPERS, WIND ENERGY CONSULTANTS AND INSTALLERS EACH CONSIDER THIS SERIOUS SAFETY RISK FOR ANY WIND ENERGY PROJECT PROPOSED FOR INSTALLATION IN AN AGRICULTURAL AREA**

NRG Systems manufactures FAA compliant painted towers for use in agricultural areas. In addition, a variety of visibility enhancement accessories, including FAA compliant aviation obstruction lighting kits, high visibility cable ball kits, and guy wire guards, are available from Renewable NRG Systems for use with such installations.

If the installation of an Meteorological Tower (MET) is being proposed for an agricultural area or in remote areas where low flying aircraft operate, NRG Systems strongly recommends those involved in the project do ALL of the following:

Become familiar with any and all applicable Federal Aviation Administration (FAA) tower visibility and lighting requirements, including FAA Advisory Circular AC 70/7460-1L “Obstruction Marking and Lighting” dated December 4, 2015 or in its current revision and ensure the installation complies with those standards and any recommendations contained therein, including but not limited to the following:



- a. Voluntary marking of meteorological towers less than 200 feet (61 m) AGL in accordance with marking guidance contained in the FAA Advisory Circular AC70/7460-1L.
- b. Painting with alternate bands of aviation orange and white paint in accordance with Chapter 3, paragraphs 3.1 through 3.4 of the FAA Advisory Circular AC70/7460-1L.
- c. Utilizing several high visibility sleeves (guy guards) on outer guy wires.
- d. Attaching spherical marker (cable) balls to the guy wires. Aviation orange marker balls should be installed according to Chapter 3, paragraph 3.5 of the FAA Advisory Circular AC70/7460-1L;

Contact the FAA's Obstruction Evaluation/Airport Airspace Analysis (OE/AAA) office (<http://oeaaa.faa.gov>) to discuss whether a "Notice of Proposed Construction or Alteration" form (FAA Form 7460-1) is required;

Contact the nearest FAA Regional or District Office regarding installation reporting requirements ([www.faa.gov/airports/news\\_information/contact\\_info/?s](http://www.faa.gov/airports/news_information/contact_info/?s));

Become familiar with any and all state and local statutes, ordinances, zoning or other regulations regarding tower visibility and lighting requirement's, as some states as well as many local jurisdictions have enacted statutes or regulations which may affect tower visibility and lighting and which may differ from FAA requirements;

Contact local regulatory agencies (*e.g.*, city and county building departments) to determine if there are any local zoning regulations relating to the installation;

Investigate whether agricultural aviation is present at or around the installation site(s) under consideration, including contacting state and local farm bureaus and/or state or national agricultural aviation organizations (*e.g.*, National Agricultural Aviation Association [<http://www.agaviation.org>]), and;

Contact local landowners, farming operations and agricultural operators and notify them of a proposed or completed installation, including specific GPS coordinates.

## 1.4 Tower Obstruction Marking

60 and 50 meter XHD painted towers meet the requirements of Federal Aviation Administration (FAA) Advisory Circular AC 70/7460-1L for Obstruction Marking and Lighting. The paint color used for obstruction marking complies with Federal Standard FED-STD-595 and the paint coating passes ASTM D3359 Standard Test Methods for Measuring Adhesion by Tape Test. Although the paint coating passes a rigorous adhesion test and great care is taken to minimize damage; scuff marks, paint chipping, and blemishes do occur to the finish during manufacturing and transportation. Although coating damage may occur, the paint finish achieves its design objective of providing obstruction marking in accordance with the FAA Advisory Circular AC 70/7460-1L for Obstruction Marking and Lighting.



ALWAYS USE VISIBILITY ENHANCING DEVICES ON TALLTOWERS INSTALLED IN AGRICULTURAL AREAS WHERE LOW FLYING AIRCRAFT OPERATE. The installation of TallTowers in agricultural areas can pose a serious risk to low-flying aircraft. **Physical contact between an agricultural aircraft and any part of a TallTower or its guy wire system can result in serious injury or death.** Consult appropriate authorities for guidance on the use of painted towers, tower lighting, high visibility guy wire balls, and/or guy guards for such installations.

## 1.5 References

ANSI/TIA-222-F Structural Standard for Antenna Supporting Structures and Antenna  
ASTM D3359 - 17 Standard Test Methods for Measuring Adhesion by Tape Test  
Encyclopedia of Anchoring - Principles and Applications of Anchoring, Hubbell Power Systems  
Federal Aviation Administration (FAA) Advisory Circular AC 70/7460-1L  
Federal Specification FED-STD-595  
Federal Specification Wire Rope and Strand RR-W-410F

## Chapter 2: Pre-Installation Guidelines

### 2.1 TallTower History

NRG Systems TallTowers™, the original tilt-up tubular towers, were first introduced in 1982 and quickly became the industry standard to quickly and easily get sensors up and into the wind to start measurements. TallTowers are delivered in complete kits, assembled on the ground and then tilted up and secured with guy wires. The 60 and 50meterXHD TallTower is ice-rated for extreme climates and exceeds EIA-222-F Standards.

### 2.2 Construction and Assembly

The NRG Systems TallTower™ is constructed of galvanized steel tubes and is guyed at six levels in four directions. Sections slide together without the use of bolts or clamps. The tower is tilted up from the ground with a gin pole and winch (not included). Lifting of the tower is done by one set of guy wires (lifting wires) attached to the ginpole. The tower is stabilized sideways with two side guy wire sets. The baseplate is hinged so both the tower and gin pole can pivot to the erected position.

### 2.3 Required Parts to Erect Tower System

NRG Systems 60 and 50 meter XHD TallTowers are supplied complete with ready-to-assemble tubes, baseplate, guy rings, pre-cut guy wires, screw-in anchors, grounding kit, and associated hardware. Screw-in earth anchors are included and are suitable for many soil types. Other anchor types are available. It is your responsibility to determine which type of anchor is appropriate for your specific site.



Please refer to the anchoring guidelines in [Appendix I](#) of this manual for more information.

A winch and ginpole are also required to raise the tower. When combined, a winch and ginpole comprise an installation kit. The installation kit (winch and ginpole) can be transported from one site to another to raise and lower several different 60 and 50 meter XHD TallTowers.

The ginpole for the 60and 50 meter XHD TallTower is NOT compatible with other NRG Systems TallTowers (**except the 60 m HD, manufactured between August 2006 and August 2007**). The ginpoles and winches from other NRG Systems TallTowers (including the *standard* 60 m TallTower (discontinued in August 2007)) are not compatible with the 60and 50 meter XHD. However, the ginpole from the 60 m HD TallTower (manufactured between August 2006 and August 2007) can be used to raise a 60 or 50 meter XHD.

Please refer to [Appendix J](#) for information regarding the required installation accessories for the 60 and 50 meter XHD TallTower. See the Glossary for pictures and descriptions of tower parts, hardware, and accessories.

## 2.4 Experience Required



**Previous experience installing other TallTowers is required for successful installation of 60 and 50 meter XHD TallTowers. If you have no prior experience with TallTower installation, seek assistance from a qualified installer.**

**2.5 Using This Manual**

There are several possible configurations of the 60and 50 meter XHD TallTower family. The variables include tower height and site layout (guy anchor footprint). This manual covers all of them. The general instructions in the main body of the manual show a 60 meter XHD configuration but it is intended to also represent the 50 meter XHD configuration. Since they are all very similar, we have chosen to put the differentiating information into appendices – one appendix per configuration. In these appendices, you will find information about selecting the appropriate tower for your wind and ice loading conditions, anchor and baseplate loads, parts lists, site layout maps, and tower assembly drawings.

## 2.6 Tools Required For Various Tasks But Not Supplied

- ¼ inch nut driver (for sensor installation)
- 5/16 inch nut driver (for hose clamps)
- 9/16 inch (14 mm) socket wrenches (for wire rope clips) – one per crew member
- Large adjustable wrench (for large bolts)



- 9/16 inch wrench, socket or open (for base plate assembly and unpacking Envirocrate)
- Piece of rebar or similar (for turning anchors)
- Hand sledge (for ground rods)
- Small adjustable wrench (for opening/closing acorn clamps)
- Small pliers (for sensor cotter pins)
- Small Phillips head (+) screwdriver (for set screws)
- Flat (-) screwdriver (for antenna mounting assembly)
- Knives (to cut electrical tape) – one per crew member
- Level, preferably with a magnetic base (to straighten the tower)
- Compass (for aligning direction sensors)
- Permanent marker (for labeling lower ends of cables)
- (2) 12 V deep cycle marine batteries (for electric winch)
- Gasoline (for hydraulic winch)
- Lifter transfer hoist (included)
- Hankmaster 5000™ guy wire tool (optional)
- Gloves
- 2-way radios or walkie-talkies
- Electric drill with 5/16 inch bit (for unpacking Envirocrate and attaching top tube)
- Band cutters (for unpacking Envirocrate)
- Wire cutters
- 2.5 m (8 foot) stepladder (for reaching end of ginpole on sloped sites)

## **2.7 Recommendation:**

With today's advanced digital camera technology, it is recommended that you film the tower lift as an educational tool for future tower lifts as well as to help to continuously improve future tower installations.

## **2.8 Unpack your tower**

### **2.8.1 Description of the Envirocrate packaging**

NRG Systems has developed the Envirocrate in an effort to reduce cardboard waste, protect the tower components and allow for more economical shipment. All the tower components including anchors and ground kit are now included on one pallet which comprises the Envirocrate. If you purchased this tower as part of a NOW System, the ginpole, electronics, sensors and associated accessories are packaged separately.

It is very important that you understand how to unpack the contents of the Envirocrate safely. The recommended sequence to unpack the tower is described in this section of the manual.



Please read this section carefully to avoid serious injury.



Picture 2-1

## 2.8.2 Tools required to unpack the Envirocrate

- 5/16 inch nut driver or electric drill with 5/16 inch bit
- 9/16 inch wrench for bolts
- Band cutters
- Gloves



WEAR APPROPRIATE PROTECTIVE GEAR AND USE CAUTION WHEN UNPACKING TALLTOWER COMPONENTS. WEAR GLOVES AND EYE PROTECTION WHILE UNPACKING THE ENVIROCRATE TO PREVENT CUTS AND OTHER INJURIES FROM BANDS AND SHARP OBJECTS. HEAVY COMPONENTS CAN SHIFT IF NOT UNPACKED CAREFULLY AND IN THE PROPER SEQUENCE. FOLLOW ALL UNPACKING INSTRUCTIONS.



USE EXTREME CAUTION WHEN UNPACKING HEAVY TALLTOWER COMPONENTS. LOOSE TALLTOWER COMPONENTS CAN CAUSE SERIOUS CRUSHING INJURIES DURING UNPACKING IF CARE IS NOT TAKEN. ALWAYS FOLLOW UNPACKING INSTRUCTIONS CAREFULLY, AND USE SUFFICIENT INSTALLATION CREW MEMBERS TO REMOVE TALLTOWER COMPONENTS FROM THE ENVIROCRATE PACKAGING IN THE PROPER SEQUENCE.





### 2.8.3 Envirocrate Access and Orientation

Ideally, you will want access to both ends of the Envirocrate to unpack the contents. If a forklift is available, that is also ideal. Remove the Envirocrate from the truck with the forklift and set the Envirocrate on an unobstructed flat area before unpacking.

It is also possible to unpack the contents with access to only one end of the Envirocrate. For example, the Envirocrate may have been placed into a truck with one end against the front wall of the truck's cargo area and no forklift available to remove the Envirocrate from the truck. In this case, you will be able to follow instructions in this section of the manual to unpack the contents and unload from the truck by hand.

**Note:** You will NOT be able to unpack the contents of the Envirocrate if the Envirocrate has been loaded into a truck sideways. If the Envirocrate has been loaded into a truck sideways, you will not have required access to the ends and will need a forklift to remove the Envirocrate.

### 2.8.4 Envirocrate Unpack Sequence – Very Important!

Once you are ready to unpack the contents of the Envirocrate, follow these steps. The general procedure for unpacking the Envirocrate is as follows:

1. With the banding cutters, cut the single horizontal band (#1) and discard. DO NOT CUT the remaining 5 bands at this time.
2. With the powered screwdriver, remove the 4 wood screws that fasten each end plate assembly down to the wood pallet.
3. Set aside the end plate assemblies. If you can only remove one end plate assembly, that is OK – remove the end plate and set it aside. The tube contents will now be exposed.
4. Remove the contents in the tubes as shown.
5. Remove the 203 mm (8 inch) diameter tubes from the 254 mm (10 inch) diameter tubes, one at a time. Recycle the protective cardboard strips. At this point, there should only be 254 mm (10 inch) diameter tubes remaining on the pallet.
6. With the band cutters, cut the three (3) bands as shown in picture 2-1.



**Picture 2-1 Envirocrate**



# Envirocrate™

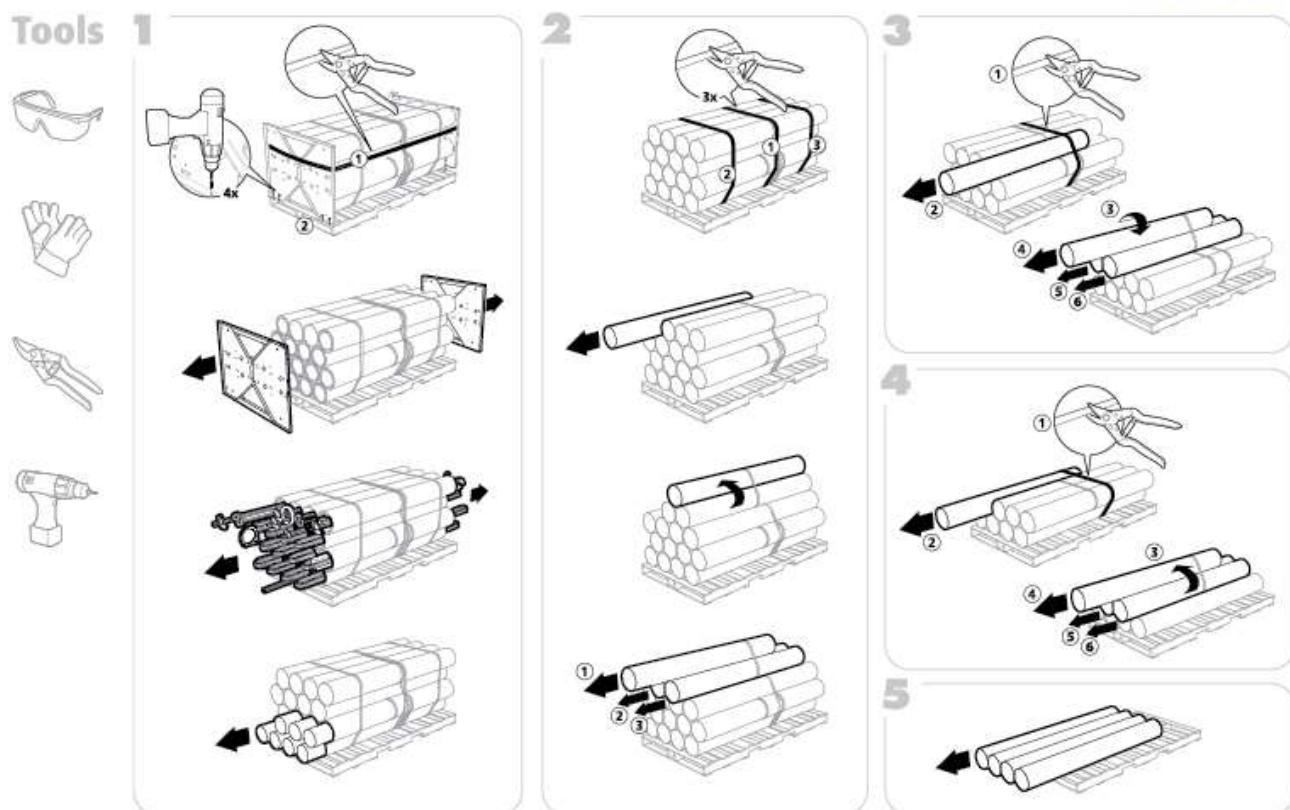

7683, Label Pallet Disassembly, Super 60m and 60m XHD TallTowers, Pallet A

Figure 2-1

- Note that one top layer tube is now free and can be removed. DO NOT CUT the inner 3 bands that are marked with the "DO NOT CUT" tags. These are safety bands that never need to be cut.
- The three remaining sections of 254 mm (10 inch) diameter tubing on the top layer are restrained by a small metal safety band (marked with a "DO NOT CUT" tag). These can be safely rearranged without cutting that band by lifting the tube closest to the edge of the Envirocrate and nesting it on the two other tubes, and the safety band will go slack. Now you may slide this top tube out from underneath the safety band and remove it from the pallet.
- Remove the remaining two tubes from the top layer (these two tubes were within the safety band).
- With the band cutters, cut another cross-band, and remove the next layer of tubes in the same manner described above. Repeat until the pallet is disassembled.



## 2.9 Site Layout

### 2.9.1 Pre-installation Planning

It is a good idea to visit the site before you order your wind measurement system. You will need to make arrangements regarding how to unload your tower system. Some site preparation such as leveling, cutting trees, or pouring concrete may also be necessary.

### 2.9.2 Soil Type and Anchors

Before ordering your tower, research the site soil and anchor type required. It is your responsibility to determine which type of anchor is appropriate for your specific site. Depending on the soil type, anchoring can take varying levels of planning, effort and time. Be sure to know what soil types you are dealing with as part of your pre-installation planning process.



USE ONLY SUITABLE TOWER ANCHORS FOR THE SOIL TYPE AT THE INSTALLATION SITE. STABILITY OF THE COMPLETED TOWER UNDER VARYING CONDITIONS (E.G., HIGH WINDS AND ICE), AND STABILITY DURING INSTALLATION, DEPENDS ON THE USE OF PROPER ANCHORS FOR THE SOIL TYPE AT THE INSTALLATION SITE. FAILURE TO USE PROPER ANCHORS COULD CAUSE THE TOWER TO FALL CAUSING SERIOUS INJURY OR DEATH OR PROPERTY DAMAGE. CONSULT WITH THE APPROPRIATE PROFESSIONALS TO FIRST DETERMINE SOIL CONDITIONS AND THEN SELECT THE PROPER ANCHOR SYSTEM BEING SURE TO FOLLOW ALL ANCHOR MANUFACTURER'S INSTRUCTIONS.

**Note:** (15) 6" screw-in anchors are included with the tower. Other anchor types must be ordered separately.

Please refer to the anchoring guidelines in [Appendix I](#) of this manual for more information.

#### **Tip: Cellular Coverage**

This is also a good opportunity to identify what type of cellular service is available at the site for those who will be using a NRG Systems iPack to transmit data. For more information on iPacks, contact NRG Systems or visit our website <https://www.nrgsystems.com/> iPack information can be found in the Symphonie Pro manual.

## 2.10 Site Layout Map

Lay out locations for the tower baseplate, guy anchors and the winch anchors on gently sloping sites (less than 5° or 1:11). Lay out the site so that the tower is laid out downwind of the baseplate, so that the tower will be lifted into the wind. If the site is on a steep slope (greater than 5°), lay out the site so that the tower is laid out uphill of the baseplate. Unless the slope is steep, it is more important to have the tower lifted into the wind. Do not attempt to install this tower on slopes greater than 10° (1:6) or in sites where it is greater than 5° down from the baseplate to both the tower *and* the winch anchor.

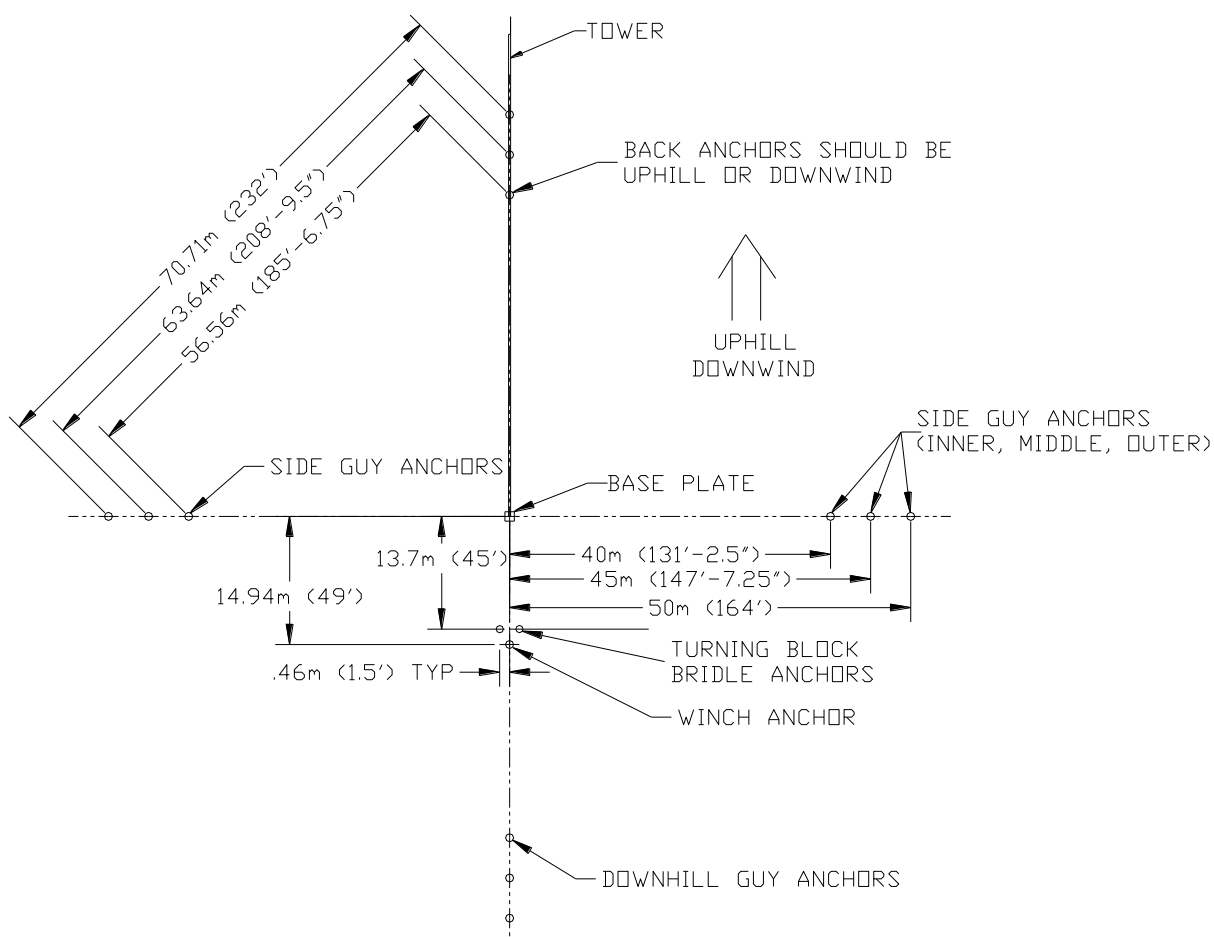

Measure carefully to place the anchor points, paying extra attention to the placement of the winch anchors. Verify that the anchor radii and the diagonal distances between anchors are correct.

**Figure 2-2: Example Site Layout Map (bird's eye view)**

**NOTE:** This site layout is an example. Please refer to your specific tower's configuration in the Appendices for the applicable site layout.

**NOTE:** TallTowers can be installed on slopes up to 10°. When laying out a TallTower installation on a slope, measure the calculated distances along the ground to place the anchors. It is not necessary to compensate for the slope. TallTower guy wires are cut long enough to allow for installation on slopes up to 10° while maintaining the ideal angle between the tower and the guys.

**NOTE:** The side guy anchors and the base plate should be on a straight line. If it is not possible to place them in the locations shown, it is better to move them in or out along the line to the baseplate than to move them off the line. Do not move them more than 1.5 m (5 feet) off the line, although some sites may require a compromise because anchors may not be able to be located at the preferred spot.



**NOTE:** Extra care will have to be taken while raising the tower if:

- Anchor placement is not perpendicular to the tower as it lies on the ground.
- Anchors are not at the same elevation.
- Side anchors and baseplate are not in a straight line.

**NOTE:** Any of these conditions will affect the side guy wire tension and the ginpole safety wire rope tension as the tower is raised. Tension will have to be continuously monitored and periodically adjusted as the tower is lifted.

Placement of the winch anchors is critical. Make sure that you measure carefully and set the anchor heads close to ground level. Angle all three anchors toward the tower at 45 degrees. Also angle the turning block bridle anchors toward each other at 30 degrees.

All this is important for proper distribution of forces and for clearance and proper operation of the ginpole. See [Site Layout Map](#) and [Anchor the Winch](#) for more information.

Lay out the site so that the tower is laid out downwind of the baseplate, to ensure that the tower will be lifted into the wind.



ALWAYS LIFT TALLTOWERS INTO THE WIND. LIFTING TALLTOWERS WITH THE WIND CAN CAUSE WIND TO PUSH THE TOWER OVER OR MAKE LIFTING FORCES UNPREDICTABLE, AND COULD RESULT IN SERIOUS INJURY OR DEATH. ALWAYS LAY OUT THE TOWER SO IT IS DOWNWIND OF THE BASEPLATE; THIS WAY YOU WILL BE LIFTING THE TOWER AGAINST THE WIND.

## Chapter 3: Tower Assembly

### 3.1 Assemble the Baseplate

The baseplate will be located according to the site layout map described in the previous section. It is often easiest to assemble the baseplate in this location. Assemble 4 of the 6 large triangular baseplate sections as shown below, inserting (8) 3/8" x 1" bolts in holes closest to the center of each triangular baseplate section. Leave nuts somewhat loose; tighten by hand only.





**Picture 3-1: Baseplate parts**



**Picture 3-2: Baseplate assembly**

While the baseplate is upside down, attach the stiffeners as shown in Picture 3-3. Use washers under the nuts inside the channels.

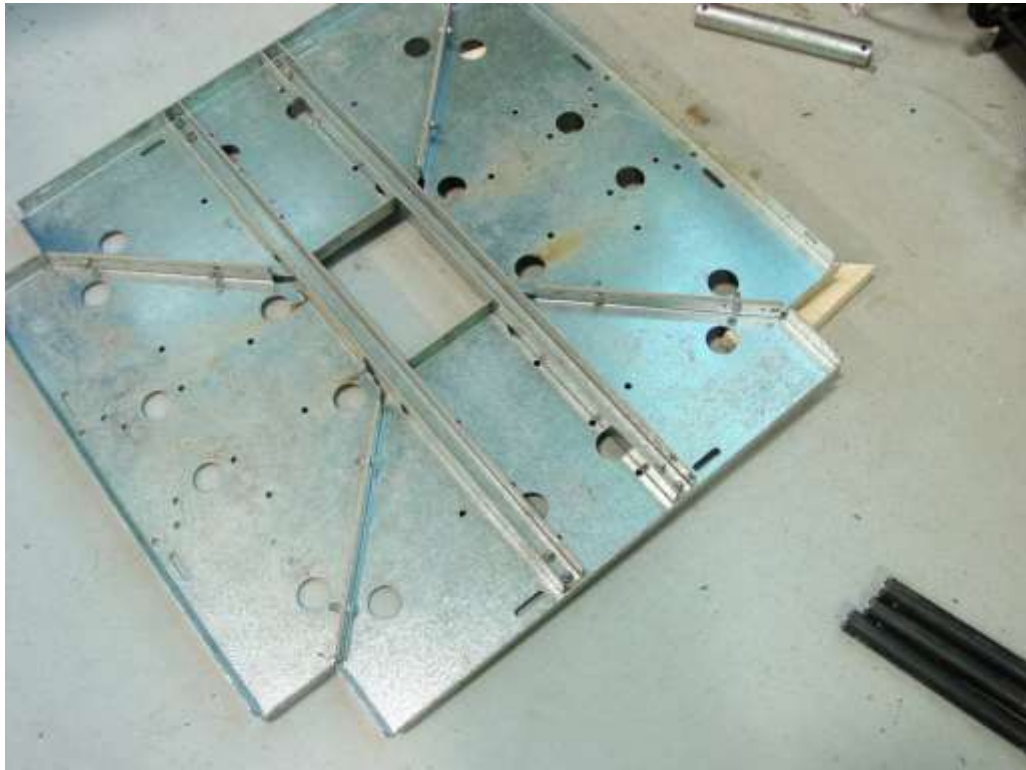

**Picture 3-3: Baseplate Stiffeners Attached**

Flip over the baseplate assembly, and prop up on one edge with a block of wood to allow access to underside of baseplate. Attach vertical pieces to the center of the baseplate as shown below in pictures



3-4 & 3-5. Make sure bent edges face outward, keeping the vertical pieces perpendicular to the stiffeners (visible through the center hole). Use washers under the nuts.



**Picture 3-4: Baseplate Assembly**



**Picture 3-5: Baseplate Assembly**



**Picture 3-6: Baseplate Assembly**

Install gussets directly across from each other, attaching them perpendicular to the vertical pieces as shown in Picture 3-7 & 3-8 below. Be sure to install the gusset bolts with the nuts toward the gusset. Tighten all bolts in the baseplate.



**Picture 3-7: Baseplate Assembly**

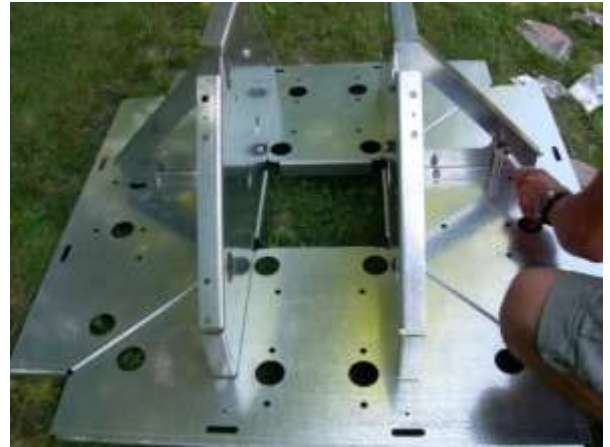

**Picture 3-8: Baseplate Assembly**





Install the channel upright doublers on the vertical pieces as shown below. Carefully align the “saddle” cutouts with the large holes in the vertical pieces so that the pivot tube can pass through. Make sure the bolt and nut are oriented as shown in Picture 3-9, nut on the outside.

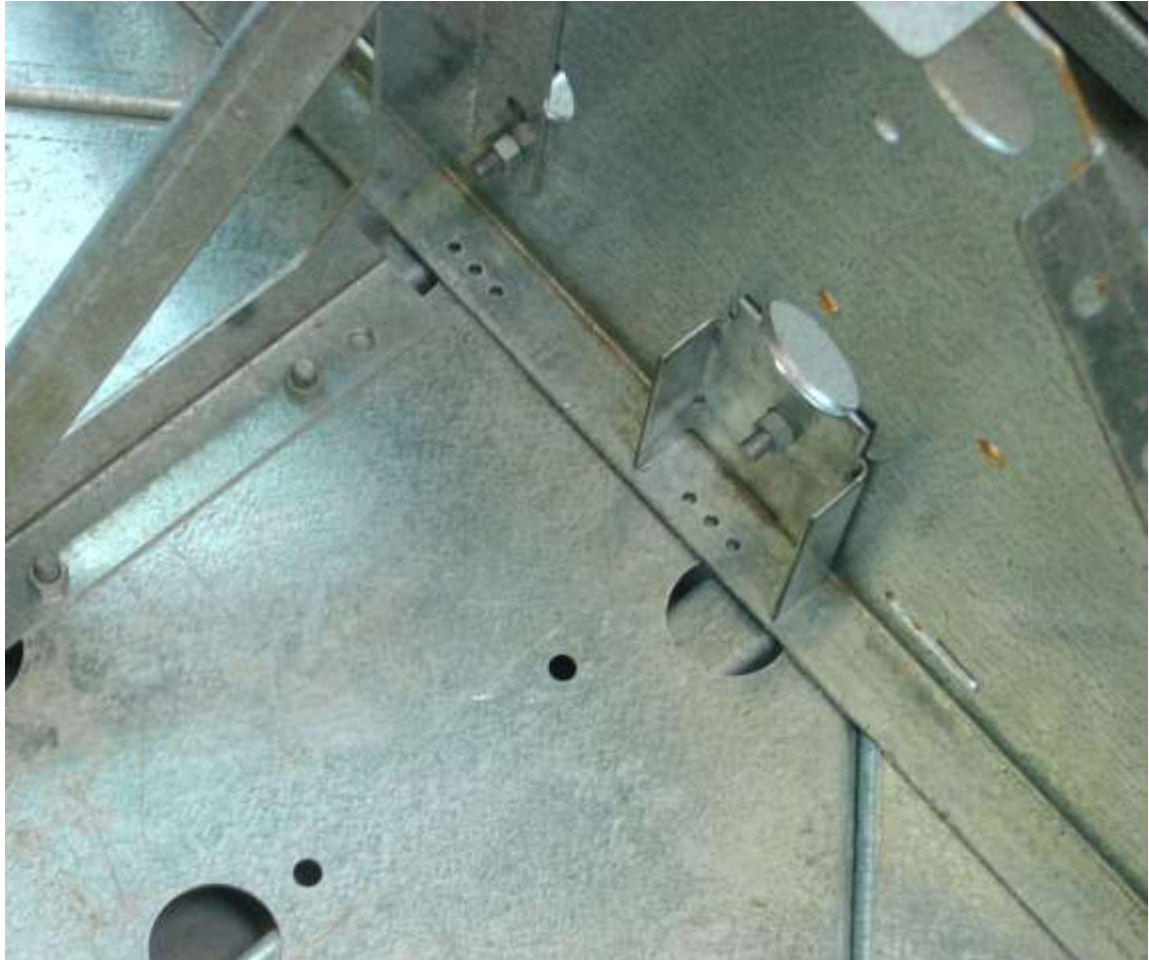

**Picture 3-9: Baseplate Assembly**

Place the baseplate at the installation site, orienting it with the gussets closer to the winch. **The area where the baseplate is located should be compacted and leveled to support the baseplate and tower.**

At the beginning of a lift, particularly for the ginpole, the winch forces are largely horizontal. These forces tend to slide the baseplate toward the winch and/or tip the baseplate up on edge. To counteract these forces, it is highly recommended that the baseplate be anchored against sliding and tipping. There are several possible techniques depending on the terrain, soil, and subsequent operations under the tower.

- Rods driven through the baseplate into the soil – With *firm*, deep soil, drive several pieces of rebar through the holes in baseplate into the soil. Angle them away from the winch and place as many as practical along the baseplate front edge (farthest from the winch).
- Rock anchors to the baseplate – On rock, or shallow soils, attach rock anchors to the baseplate, particularly along the front edge. These should be positioned and attached to hold the edge of the baseplate down as well as keep it from sliding.



- Cable to the guy anchor – A cable made up as a bridle connected to the tower tube pivot pipe can be run to the inner anchor opposite the winch or to an anchor nearer the baseplate. See Figure 3-1 below for details.

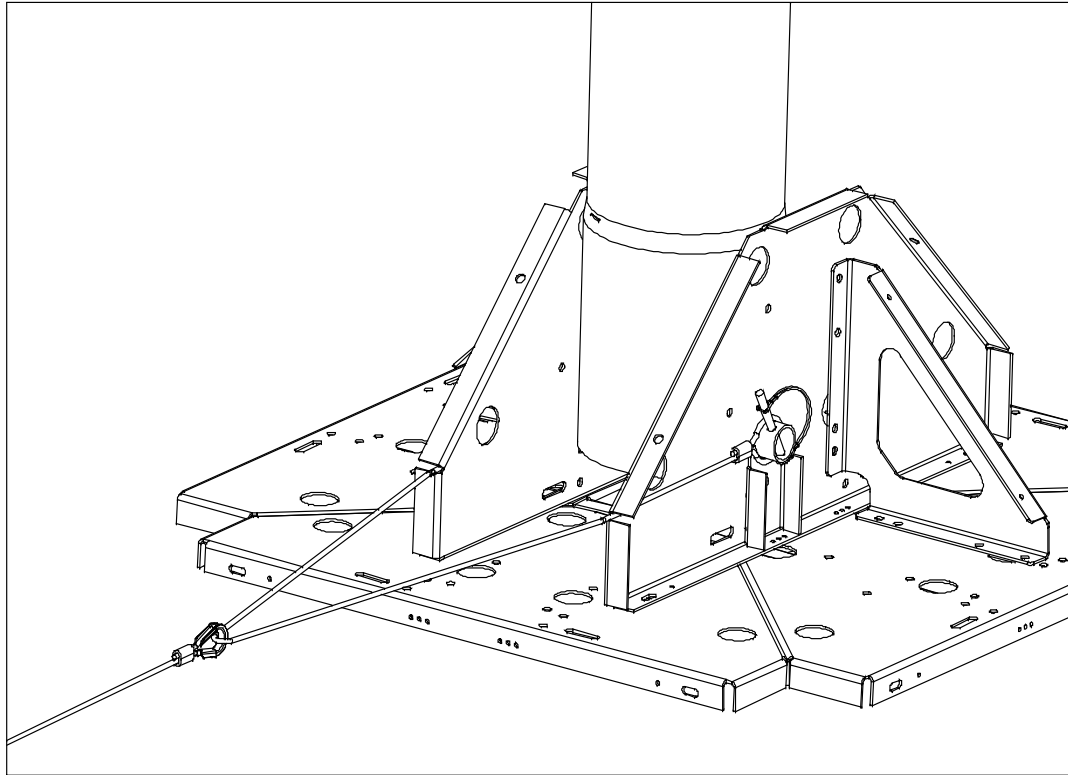

**Figure 3-1**

### **3.1.1 Ground Rods and Tower Grounding**

Drive ground rods through the baseplate holes to provide a grounding pathway for the tower and additional anchoring for the baseplate. Affix a 5/8" acorn clamp to each of the ground rods. Clamp one end of the bare 8-gauge copper wire to the acorn clamp and the other end to the tower, affixed to a ground lug and screwed into the baseplate. More information on grounding your tower and equipment can be found in Appendix G: [Grounding Tubular Towers](#)



**Picture 3-10 & 3-11: Grounding set-up (3-10 shows 80 meter baseplate)**

### 3.2 Install the Anchors

See [Appendix I](#): Anchoring Guidelines at the end of this manual for more information on installing anchors. Depending on the soil type, anchoring can take varying levels of planning, effort and time. Be sure to know what soil types you are dealing with as part of your pre-installation planning process. Leave the eye of screw-in anchors about 150 mm (6 inches) above ground.



**USE ONLY SUITABLE TOWER ANCHORS FOR THE SOIL TYPE AT THE INSTALLATION SITE. STABILITY OF THE COMPLETED TOWER UNDER VARYING CONDITIONS (E.G., HIGH WINDS AND ICE), AND STABILITY DURING INSTALLATION, DEPENDS ON THE USE OF PROPER ANCHORS FOR THE SOIL TYPE AT THE INSTALLATION SITE. FAILURE TO USE PROPER ANCHORS COULD CAUSE THE TOWER TO FALL CAUSING SERIOUS INJURY OR DEATH OR PROPERTY DAMAGE. CONSULT WITH THE APPROPRIATE PROFESSIONALS TO FIRST DETERMINE SOIL CONDITIONS AND THEN SELECT THE PROPER ANCHOR SYSTEM BEING SURE TO FOLLOW ALL ANCHOR MANUFACTURER'S INSTRUCTIONS.**

### 3.3 Tube Layout

Lay out the disassembled tube sections on the ground according to sequence described, beginning at the baseplate. Pay close attention to the location of the guy rings, the 1.9 m tube (marked with a band of blue electrical tape) and the transition tube. Consult the appropriate drawing in the Appendices for additional information.





**SI Units**

Tube Sequence in each section <b>A guy ring is placed over the last tube listed in each section (except Section 7).</b>						
Section 1	Section 2	Section 3	Section 4	Section 5	Section 6	Section 7
Base Tube + (6) 2.2 m, 254 mm dia. tubes	(6) 2.2 m, 254 mm dia. tubes	(2) 2.2 m, 254 mm dia. tubes + (1) 1.9 m, 254 mm dia. tube + (1) transition tube + (1) 2.2 m, 203 mm dia. tube	(4) 2.2 m, 203 mm dia. tubes	(4) 2.2 m, 203 mm dia. tubes	(5) 2.2 m, 203 mm dia. tubes	(1) 2.2 m, 203 mm dia. tube
Guys attached to this guy ring are color coded: Red	Guys attached to this guy ring are color coded: White	Guys attached to this guy ring are color coded: Black	Guys attached to this guy ring are color coded: Yellow	Guys attached to this guy ring are color coded: Blue	Guys attached to this guy ring are color coded: Green	No guy ring on this section

**Table 3-1**



**Imperial Units**

Tube Sequence in each section						
<b>A guy ring is placed over the last tube listed in each section (except Section 7)</b>						
Section 1	Section 2	Section 3	Section 4	Section 5	Section 6	Section 7
Base Tube + (6) 87 inch, 10 inch dia. tubes	(6) 87 inch, 10 inch dia. tubes	(2) 87 inch, 10 inch dia. tubes + (1) 73 inch, 10 inch dia. tube + (1) transition tube + (1) 87 inch, 8 inch dia. tube	(4) 87 inch, 8 inch dia. tubes	(4) 87 inch, 8 inch dia. tubes	(5) 87 inch, 8 inch dia. tubes	(1) 87 inch, 8 inch dia. tube
Guys attached to this guy ring are color coded: Red	Guys attached to this guy ring are color coded: White	Guys attached to this guy ring are color coded: Black	Guys attached to this guy ring are color coded: Yellow	Guys attached to this guy ring are color coded: Blue	Guys attached to this guy ring are color coded: Green	No guy ring on this section

**Table 3-2**



### 3.4 Install the Tower Base Tube

Identify the base tube. The base tube has a hole drilled through the flared (wider) end. Attach the base tube to the baseplate using the pivot pipe through the lower holes in the center of the baseplate sides. Secure the pivot pipe with a quick release pin.



**Picture 3-12: Baseplate assembly**

Slide tube sections together until the end of the interior tube is inserted all the way into the outer tube's flare. The inner tube will be stopped. Aligning the weld seams (visible in interior of tube) of each tower section will make it easier to slide the sections together. Continue to assemble the tubes and place guy rings over the tubes according to the sequence above. Make sure the guy ring is placed so the guy ring corners are bent towards the baseplate, and the guy ring corners are in line with each anchor point. Place wood blocks every 5 to 6 meters (15 – 20 feet) to support the tower above the ground, keeping the tower as straight and flat as possible.

**Note:** Do not use oil on tower joints. This can cause tower failure if the tubes self-flare.



**Picture 3-13: tower assembly support**



As indicated in the Tube Layout tables, there is no guy ring placed over the top tube. Therefore, secure the top tube using screws as shown.

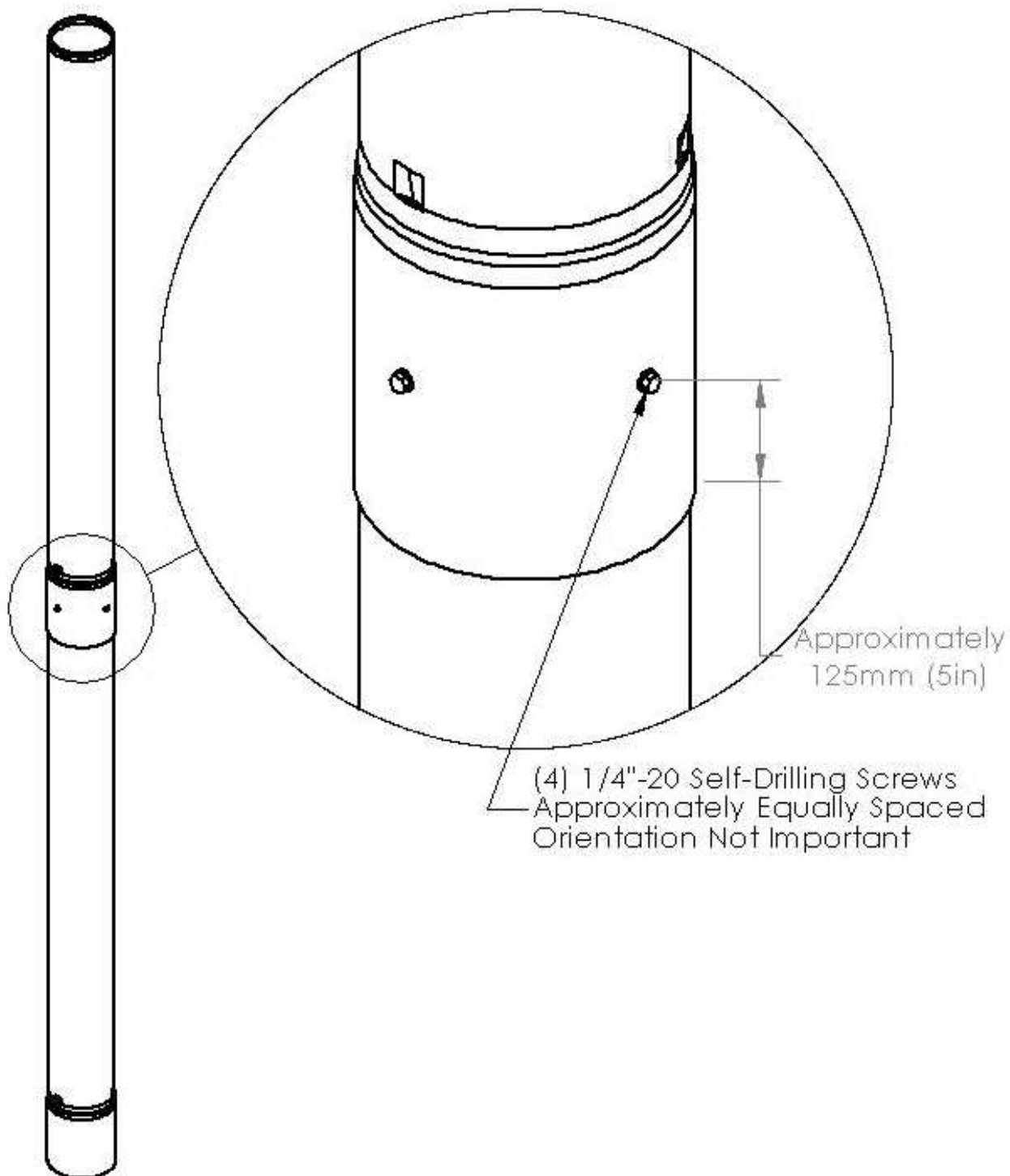

Figure 3-2



### 3.5 Attach the Lightning Rod

Attach the lightning spike at the top of the tower using the hose clamps provided. Overlap the tower and lightning spike a minimum of 18 inches for a stable installation. To comply with United States FAA tower height limits, and for more details on lightning protection, see [Appendix G](#).



**Picture 3-14: Lightning rod attachment**

If your tower is painted, you will need to prepare the surface of the top tower tube by removing the orange paint directly beneath the lightning spike. Use a grinder or other suitable device to remove the paint from the tube to ensure the lightning spike will be in direct contact with bare metal. Once the paint is removed, apply a liberal layer of rust-prevention coating (such as Sanchem, Inc. NO-OX-ID "A-SPECIAL") to ensure a long-term bond between the lightning rod and metal tube.

### 3.6 Tower Pre-lift

During the first lift of a tower, the many slip joints will settle to the full engagement. During this settling, the distances from the base to any given point on the tower will shorten, and the individual tubes may rotate. Therefore, it is recommended that the tower be "Pre-Lifted" before the booms, sensors, and cables are permanently attached. The "Pre-Lift" can be only a few feet, but the entire tower should leave the ground. Doing this also is a good way to avoid endangering the booms, sensors, and cabling should there be an unforeseen problem.

### 3.7 Attach sensors and booms

Assemble the sensors, sensor boots and sensor signal cables to the booms. Wrap the sensor signal cables to the boom as shown below. Secure with weather rated electrical tape such as Scotch Super 88. Secure the booms to the tower with the supplied hose clamps.



**Picture 3-15: Attach sensors to booms**

If you purchased the sensors and booms as part of an NRG-NOW System, cabling was supplied for (1) 60 meter level direction vane, (2) 60 meter level anemometers, (1) 50 meter level direction vane, (2) 50 meter level anemometers and (2) 40 meter level anemometers. It is always easiest to run the cables from the sensor and booms down the tower.





**Picture 3-16: Hose clamp booms to tower**

### **3.7.1 Spiral Wrap Your Sensor Cables**

Spiral wrap sensor cables around the tower, one wrap per tube joint. When you reach the transition tube and the short (1.8 meter) tube, treat them as just one tube. Use electrical tape to tape the sensor cables to the tower every few meters. Also tape cables to the tower above and below each guy ring. Where the cables cross each guy ring, protect the cables by wrapping them with a thick layer of electrical tape as shown below. The spiral promotes vortex shedding and reduces natural frequency oscillations of the tower.



**Picture 3-17: Spiral wrap sensor cable**



## 3.8 Attach the Guy Wires

### 3.8.1 Organize and Layout the Lifters and Guy Wires

Sort out and identify the different length guy wires and match them with the appropriate guy ring level by setting them to the side of the tower at the corresponding guy level. The guy wires are color coded to make this job easier. You will have 18 guy wires and 6 lifter wires (the 50 meter XHD has 15 guy wires and 5 lifter wires). All wires **MUST** be placed correctly.

Highest level = 6 (green)

Guy Ring Level	Lifter Label Text	Label Color
1	11.7 m (38 feet)	Red
2	23 m (76 feet)	White
3	31 m (101 feet)	Black
4	38.7 m (127 feet)	Yellow
5	46.5 m (155 feet)	Blue
6	56.3 m (185 feet)	Green

**Table 3-3**

**NOTE:** The 50 meter XHD doesn't have level 6.

Identify the lifter wire for each level. It is recommended that back guy wires (the guy wires opposite the winch) are attached to their guy rings, rolled out, and secured to their anchors first, followed by the side guy wires, then the front guy wires/lifters to eliminate crossing.



#### **Secure back guy wires to anchors first!**

There are 2 ways to accurately measure, then attach the back guy wires to the back anchors.

1. If the site is flat with minimal ground obstruction. Attach level one back guy wire to level one guy ring then roll the wire out to the first side anchor. Pull tight/straight and mark the distance over the anchor with a piece of tape. Walk the wire to the correct back anchor and attach with wire rope clips at the taped point. Repeat process for levels 2 through 6.
2. Attach back guy wire to guy ring, then measure the correct length using the chart from Table 3-4 below. Tape correct length on wire, then attach to correct back anchor. Repeat process for all levels starting at the bottom of the tower.

Guy Ring Level	Back Guy Wire Length	Label Color
1	136.6 feet	Red
2	150.6 feet	White
3	178.4 feet	Black
4	184.4 feet	Yellow
5	223.5 feet	Blue
6	246.5 feet	Green

**Table 3-4**



### 3.8.2 Shackle Guy Wires To the Guy Rings

Secure the back guy wires first to their corresponding guy rings using the shackles. Attach the guy wires to the guy ring holes under the tower tube. Roll out the back guy wires to their anchor points and secure as described below. Next secure the side guy wires to their corresponding guy rings using the shackles. These guy wires will attach to the side guy ring holes. Roll the side guy wires out to their anchor points and secure as described below.

### 3.8.3 Roll out each Guy Wire from the Tower to its Anchor Point

Roll out side and back guy wires from their guy rings to their anchor points. Do not allow twists or kinks in the guy wires. The guy wire and lifter coils can be uncoiled in a hand over hand method while walking out towards each anchor or unrolled using a “Hankmaster 5000” tool (see [Appendix M](#)).



**CORRECT**

**Picture 3-18: Roll out guy wire-Correct**

Do **not** un-spool cable off the side of the coil as shown below.



**NO!**



### Picture 3-19: Do NOT unspool guy wire

The Hankmaster can be used to roll the guy wires out to the anchors. See [Appendix N](#) for instructions for building and using a Hankmaster.



Picture 3-20: Optional spooler to help in the field

Pass the split rings through the eye of each shackle bolt to keep the shackle pins from loosening.



Picture 3-21:

### 3.8.4 Secure Guy Wires to the Anchors

Secure guy wires to the back and side anchors by threading the cable through the anchor loop and clamping the cable onto itself using 3 wire rope clips. Place the wire rope clip on the wire so the saddle





(the forged, grooved part) cradles the wire coming from the tower and the “U” bolt part clamps down on the dead end of the guy wire (“**Never saddle a dead horse**” may help you to remember how to secure the wire rope clips).



Picture 3-22

Attach wire rope clips



Picture 3-23

Leave a little slack in the guy wire, and tighten the wire rope clip nuts. Don't tighten the wire rope clip nuts too tightly; you will need to adjust the guy length numerous times as the tower is erected.

### 3.8.5 Shackle Lifter Wires to the Guy Rings

Secure the lifter wires to the guy ring holes on the top of the tower tube. Carefully lay out the lifters in an orderly fashion. The unattached ends can easily become entangled around each other and the other guy wires lying on the ground. Make sure that all back and side guy wires are underneath the lifter guy wires. Keeping the lifter wires organized will avoid having to stop during the lift process to untangle the lifters.

## 3.9 Assemble the Ginpole

### 3.9.1 Lay out the Ginpole Tubes

Identify the ginpole and helper ginpole tubes and hardware. Refer to the Glossary in [Appendix M](#) for pictures and descriptions of ginpole parts.

### 3.9.2 Attach the Ginpole Base Tube to the Baseplate

The ginpole base tube will lie on top of the tower base tube. Place the ginpole base tube with holes between the baseplate's vertical channels. **Insert the safety cable into the ginpole base tube.** Line up the holes in the ginpole base tube with the holes in the baseplate's vertical channels and insert the pivot pipe through the baseplate holes, spacers, and the eye in the safety cable. Secure the pivot pipe with the quick release pins.



**Picture 3-24: Attach ginpole base tube and safety cable**

### **3.9.3 Slide Together the 7 Tubes that Comprise the Ginpole**

Slide sections together until a hard stop is reached, and thread the safety cable through each tube of the ginpole as it is assembled. Aligning the weld seams (visible on interior of tubes) of each ginpole section will make it easier to slide the sections together. Place a log, sawhorse, or other type of support underneath the 5<sup>th</sup> or 6<sup>th</sup> section to slightly raise the ginpole from the tower.



**Picture 3-25: Ginpole assembly**

Slide the top ginpole section on so that the slot in the ginpole top is perpendicular to the ground.





### 3.9.4 Attach the Ginpole Top Mounting Hardware

Bolt the coupler plates to the top section of the ginpole with the two large bolts (1 inch x 10 inches), making sure that the inner bolt (closer to the base of the tower) goes through the eye of the ginpole safety cable. Also place a supplied 1/2" X 2 1/2" bolt at the end of the coupler arms.

Shackle the supplied winch cable turning block to the coupler plates using the supplied 1/2 " X 2 1/2 " bolt placed through the coupler plate hole shown in the pictures below.



Picture 3-26



Picture 3-27



Picture 3-28

### 3.9.5 Attach the Lifter Wires

Attach each of the six lifter wires to the ginpole using the supplied hardware pins. Be sure to connect them in the proper order and make sure they are not tangled with each other or side or back guy wires.

Lifter #	Lifter Color	Coupler Plate Hole
6	Green	6 (top - away from tower base)
5	Blue	5
4	Yellow	4
3	Black	3
2	White	2
1	Red	1 (bottom – toward tower base)

NOTE: The 50 meter XHD doesn't have level 6. Table 3-5



**Picture 3-29: Attach lifter to coupler plate**

### **3.9.6 Assemble the Helper Ginpole**

Slide the supplied bolt through the holes on the helper ginpole and helper ginpole sheaves and secure with the supplied nut.



**Picture 3-30: Ginpole top tube sheave attachment**

### **3.9.7 Configure the Helper Ginpole**

Put the helper ginpole standing vertically (pulleys pointing towards the sky) on the baseplate behind the main ginpole. Line up the holes in the helper ginpole with the holes in the baseplate's vertical channels. Slide a pivot pin through holes to secure in a vertical position. Secure the pivot pin with quick release pins.



**Picture 3-31: Helper ginpole assembly**

### **3.9.8 Assemble the winch control bar**

Using the hardware that is loosely attached to the bottom of the winch, assemble the winch control bar (handle) as shown below.



**Picture 3-32: Old winch control bar attachment**



**Picture 3-33: S900 electric winch assembly**

If you have the hydraulic winch, attach the winch control bar to the baseplate using the two 2 ½" long half-inch bolts. Tighten nuts with the provided tools.



**Picture 3-34: Hydraulic Winch assembly**

**IMPORTANT:** Once the ginpole is raised and the top of the tower begins to lift from the ground, keep the cable in the center of the drum as show below. This will make it easier to control the winding of the winch cable during the period of highest loading. Once the tower has reached approximately 30 degrees, loads are reduced, and you can then begin winding the cable on the ends of the drum.



**Figure 3-3: Hydraulic Winch**

### 3.9.9 Anchor the winch

Attach the winch and turning block as shown. Avoid kinks or twists in the shackles and cables.



**Picture 3-35: Electric winch**



**Picture 3-36: Hydraulic winch**





### 3.9.10 Assemble the Bridle Cable and Bulley

Attach one end of each bridle cable to each bridle cable anchor using the supplied shackle. Attach the other ends of the bridle cables to the supplied shackle and attach the shackle to the supplied bridle anchor pulley. See picture 3-37 below.



Picture 3-37: Bridle cable assembly

### 3.10 Set up the Winch Cable

Release the winch brake/clutch so that the cable can be un-spooled. **The cable must un-spool from the bottom of the cable drum in order for the brake to function properly.** Pull out the winch cable and route as listed:

1. Over one of the helper ginpole sheaves.
2. Through the turning block at the top of the main ginpole.
3. Over another helper ginpole sheaves.
4. Through the turning block at the bridle cables (in front of the winch).
5. Over the top of the helper ginpole sheaves.
6. Ending at the top of the main ginpole.

**Note:** To open the supplied pulleys, remove the pin from one side of the pulley.

**Note:** When putting the winch cable over the top of the helper gin pole, it does not matter which cable goes in which helper ginpole sheave. It is also not necessary to center the helper ginpole pulleys.



**Picture 3-38: Winch & Bridle Assembly set-up**



**Picture 3-39: Winch cable wound on pulleys**



**Picture 3-40: Winch cable over helper ginpole**

### **3.10.1 Secure Winch Cable to Top of Ginpole**

Connect the thimble at the end of the winch cable through the bolt hole in the coupler plates as shown below. Be sure to use the supplied  $\frac{1}{2}$ " X  $2\frac{1}{2}$ " bolt and NOT the quick release pins.





**Warning:** The top of the ginpole is designed to have two load points: the bolt hole near the wider part of the coupler plate, and the hole closest to the base of the ginpole (see photo picture 3-41 below). Failure to use both load points can overload the coupler plate and result in a ginpole failure. Please assemble ginpole top hardware and winch cable rigging exactly as shown in Picture 3-41 below.



**Picture 3-41: Winch cable attaches to top of ginpole**

Your tower was supplied with 12 mm (1/2 inch) brown polypropylene rope. A single rope tied to each side anchor is sufficient. These are used to stabilize the ginpole while it is being raised.

**Warning:** Failure to use the ginpole ropes will cause the ginpole to fall over to either side during the lift. Be sure to tie the safety ropes securely to the side anchors; the ginpole is very heavy, and the safety ropes can't be controlled by hand.



**ALWAYS SECURE THE WINCH TO A WINCH ANCHOR. FAILURE TO USE A WINCH ANCHOR COULD CAUSE EXCESSIVE LOADS ON THE VEHICLE USED TO SUPPORT THE WINCH AND WINCH PLATE. EXCESSIVE LOADS CAN RESULT IN THE VEHICLE BEING HOISTED IN THE AIR CAUSING SERIOUS INJURY OR DEATH OR PROPERTY DAMAGE. NEVER RELY ON AN UNSECURED WINCH AND SUPPORT PLATE – ALWAYS USE A WINCH ANCHOR.**

### **3.10.2 Option of using the NRG Systems 80 meter winch to raise the 60m XHD TallTower.**

Installers who own or are familiar with and own the 80 m winch are now allowed to use this winch to raise the 60m XHD tower. See full procedure in Appendix S.



## Chapter 4: Installation Process

### 4.1 Ginpole Tilt-Up

#### 4.1.1 Confirm all lifters and shackles are secure

Carefully double check all connection points to make sure everything is secure before starting to lift the ginpole.

#### 4.1.2 Connect the Hydraulic Power Unit (HPU) / power the winch

NRG Systems recommends using an HPU with your hydraulic winch. If choosing to use an electric winch, you will need two fully charged 100 amp hour deep cycle batteries (not supplied) connected in parallel.

#### 4.1.3 Lift the ginpole

Make sure the ginpole remains centered side to side and that the brown ropes are both snug. If the ginpole is off center, carefully adjust the ropes to re-center. As the ginpole comes up, watch the lifters to make sure they are not caught on objects in the area (the winch, stumps, debris, rocks, equipment, etc.). Also check that they are not crossed over each other or the other guy wires. When the lifter wires tighten, **stop**.

Do not lift the tower yet. Check that the shackles are not twisted at the guy rings. Remove the helper ginpole.



Picture 4-1: Ginpole tilt-up, Helper ginpole attached



Picture 4-2: Ginpole high enough to remove helper ginpole



## 4.2.1 Understanding Guy Wire Tensioning While Raising Tall Towers (Do not raise the tower yet)

As a tower is raised, unless the anchors are placed in precisely their correct positions, and unless the site is perfectly level, some guy wires will tighten and some will loosen. The same is true as a tower is lowered on the same site. For this reason, guy wire tension must be checked and adjusted as needed to maintain uniform tension until the tower installation procedure is complete.



**ALWAYS MONITOR AND MAINTAIN PROPER TENSION OF SIDE GUY WIRES DURING GINPOLE AND TOWER LIFTING. IF SIDE GUY WIRES ARE SUBJECTED TO EXCESSIVE TENSION THEY CAN BREAK CAUSING A SUDDEN AND DANGEROUS INSTABILITY OF THE TOWER. SERIOUS INJURY OR DEATH OR PROPERTY DAMAGE COULD RESULT. TOO LITTLE TENSION CAN RESULT IN TOWER DAMAGE DUE TO BUCKLING. IT IS THEREFORE CRITICAL TO ALWAYS MONITOR AND MAINTAIN PROPER SIDE GUY WIRE TENSION DURING THE GINPOLE AND TOWER LIFTING PROCESS.**

A wire that becomes too tight can put very high forces on both the anchor and the tower. This force can rapidly grow if the tower lifting or lowering procedure continues. These high forces can suddenly buckle the tower and cause it to fall, endangering the tower installation crew and possibly damaging any vehicles or equipment nearby. Do not let the tower be bowed to the side more than two tower tube diameters away from a straight line. If the tower is bowed more than this, the side guys should be adjusted to straighten the tower.

It is also critically important that adequate tension be maintained on side guy wires at all times during the lifting procedure to provide side support for the tower. Too little tension can allow the tower to buckle to the side. Too much tension may cause failure of the tower, anchors, or guy wires. There must always be visible slack in the guy wires. If no slack is visible, the tension is too great. Refer to the charts in Section [4.8.1 Pulse Method](#) for proper guy tension.



The small footprint configurations significantly increase side guy forces during erecting and lowering. Even experienced installation teams have been surprised by these forces. It is critical to keep the tower straight at all times. This is particularly important when the tower is near the ground where forces are at their greatest and most difficult to control. Use the standard footprint configuration whenever possible.

Once the tower is vertical, two people of average size, pulling by hand, can properly tension the guy wires. A cable grabber (Chicago grip) and hand come-along winch can be used together to help adjust guy wire tensions.

Be sure that guy wires do not get caught on tree branches, roots, rocks, or other obstructions. It is especially critical to keep guy wires away from the winch's free spool lever so that the winch cable is not accidentally released.

This sequence of observing, communicating observations, issuing commands to guy wire tenders, adjusting the side guy wires and re-tightening wire rope clips must be well understood before lifting a





tower. The sequence will be repeated many times before a tower installation is completed on all but the most flat and level sites.

## 4.2.2 Adjusting Guy Wires (The “Inchworm” Method)

### 4.2.2.1 Loosening Guy Wires

As the tower is raised, the side guys may become tight. To adjust the cable, start by making sure the 3 wire rope clips are secure. Tighten using a 9/16” socket. Then:

- Loosen the upper clip and pull a length of the tail through the clip, creating a loop as shown below. Tighten the upper clip to “trap” the loop between the upper clip and the lower clips.



Picture 4-3: Loosen top wire rope clip



Picture 4-4: pull slack into line (make a loop)



Picture 4-5: Re-tighten top clips before loosening bottom



- Now loosen the lower clips, loosening the lowest clip slowly, allowing the loop to slide, which will slacken the guy wire.
- Retighten the lowest wire rope clip.



**Picture 4-6: Loosen bottom clip slowly**



**Picture 4-7: Re-tighten bottom slip when slack is gone**

- Repeat as necessary from step 1 to create the proper cable tension.

#### 4.2.2.2 Tightening Guy Wires

As with loosening, make sure to start with all 3 wire rope clips secure. Tighten using a wrench as shown below. Then:

- Loosen the lower 2 wire rope clips as shown below.
- Pull the 2 cables apart to form a loop (similar to the loop made while loosening), then tighten the lowest rope clip to trap the loop between the upper and lower rope clips as shown below.
- Loosen the upper clips and pull the tail to remove the loop.
- Re-tighten upper wire rope clips.



**Picture 4-8: Loosen bottom 2 clips**



**Picture 4-9: pull apart to make a loop, Re-tighten bottom clip**





**Picture 4-10: Loosen top clip**



**Picture 4-11: pull tail to remove loop, Re-tighten top clips**

- Repeat as necessary from step 1 to tighten the cable.

#### **4.2.3 Monitor the weather**

It is important to monitor the weather on the day of the lift. If excessive wind speed of higher than 10 m/s gusts are occurring, it may be a good idea to wait until the winds die down before lifting the tower.



CAREFULLY MONITOR ANY WIND DURING THE LIFT AS WIND BLOWING IN THE DIRECTION OF THE LIFT (TOWARD THE WINCH) CAN CAUSE DANGEROUS INSTABILITY AND A LOSS OF CONTROL OF THE TOWER. IF THE TOWER BECOMES UNSTABLE DURING THE LIFT, SERIOUS INJURY OR DEATH CAN OCCUR. ALWAYS MONITOR BACK GUY WIRE TENSION DURING THE LIFT TO ENSURE PROPER RESISTANCE IS PROVIDED TO PREVENT INSTABILITY.

#### **4.3 Tower Lift Crew**

We suggest the following organization to form an efficient and safe crew to erect NRG TallTowers. Each member of the lift crew should have a good understanding of the tasks they are required to perform during the lift.

Five Member Crew:

**Crew leader:** This person usually operates the winch and coordinates the other members. It is especially important to maintain clear communication among the members of the crew. The tower footprint is large and walkie-talkie radios are highly recommended.

**Side guy wire tenders:** These two people will attend to each side guy anchor and adjust side guy wires. They must be familiar with taking in and letting out guy wires. See the pictures describing the “inchworm” technique for safely adjusting guy wires.





Observers: Two people to assist adjusting side guys, tending the back guy wires at the end of the lift, and otherwise observing the tower and guy wires.

#### 4.4 Lift the Tower

When all crew members are ready, the winch operator will begin to lift the tower. Help the cable to wind evenly by using the winch control handle to move the winch motor from side to side.

**Warning:** Allowing the cable to wind unevenly will result in crossovers that will damage the cable and fill the winch drum before the tower is fully raised.

Lift the tower about 1 m (3 feet) off the ground while checking side guy tensions. The lifters are set up to produce a slight bow in the tower, with the top 0.3 m to 0.6 m (1 to 2 feet) higher than the middle (we refer to this as a “positive curve”). This is normal, and it needs to be maintained throughout the entire lift to avoid tower buckling or collapse. Adjust the side guy wire tensions to prevent the tower from either falling off to one side or bowing which could damage the tower.



**THE TOWER MUST REMAIN STRAIGHT SIDE-TO-SIDE AND MAINTAIN A POSITIVE CURVE AS DESCRIBED ABOVE. FAILURE TO MAINTAIN THE PROPER SHAPE CAN CAUSE THE TOWER TO COLLAPSE, ENDANGERING THE CREW AND EQUIPMENT. NEVER EXCEED THE MAXIMUM PERMISSIBLE TOWER DEFLECTIONS (LISTED BELOW IN THE AT ANY POINT DURING THE LIFT.**

**Never exceed the maximum permissible tower deflections (listed below in the Critical Installation Step).**

##### 4.4.1 Critical Installation Step: Permissible Deflection

Tower deflection shall not exceed the following maximum permissible deflections:

- Tower deflection  $\leq$  0.25 meters (0.83 feet) or one (1), 10” tube diameter, between guy levels
- Tower deflection  $\leq$  0.51 meters (1.7 feet) or (2), 10” tube diameters, between three (3) guy levels
- Tower deflection  $\leq$  1.0 meters (3.3 feet) or (4), 10” tube diameters, across the entire tower

**Watch the winch anchors for movement.** The maximum lifting force will be experienced when the tower is first lifted a few feet off the ground. If the winch anchors will not hold, either the anchor was not installed correctly or another type of anchor is needed. See [Appendix I: Anchoring Guidelines](#) for more information.

**Watch the tower baseplate for movement toward the winch.** If either the winch anchors won’t hold or the baseplate slips, immediately lower the tower.

**Everything looks OK,** continue to lift the tower a little at a time, checking tower side guy tension along the way. At times, it may be necessary to adjust the side guy wire tension, particularly if the side guys are above, below, or otherwise out of line with the tower pivot. In addition, regularly check the ginpole side guys to make sure their tensions are roughly equal. Do these checks and adjustments **ONLY** when the



winch is stopped. Readjust with wire rope clips, letting cable out or pulling loose cable in (see “inchworm” technique). In the case of the ginpole, lengthen the *loose* rope and shorten the *tight* rope (sounds backward, but it is correct). In certain circumstances, like when the winch is off line with the tower, the ginpole loads will be balanced only when the ginpole leans slightly to the side. However, do not allow the ginpole to be at a severe angle to the base plate pivot since the pivot loads will be all on one side of the ginpole. In this case, lower the tower, and then realign the tower with respect to the winch and/or level the baseplate as needed. Extreme imbalance in the ginpole side guys may overload the ginpole, resulting in a ginpole collapse.

Work slowly and smoothly. Fast, uneven movements tend to make the tower bounce, shake or swing. *Be sure that communication between all members of the lifting team is clear and concise.* Continue lifting and adjusting until the tower is about 70 degrees above horizontal (just about three quarters of the way). **STOP!**

#### 4.4.2 Back Guy Wire Tension

Beyond 70 degrees above horizontal, it is absolutely essential that tension is maintained on back guy wires #2, #4 and #6 during the last part of the lift. The tower will lift very easily at this point because the weight of the ginpole and winch will be enough to tip the tower with little effort from the winch. Any wind blowing in the direction of the lift will also reduce the load on the winch; excessive wind in the direction of the lift can lead to a loss of control of the tower. *Therefore, the crew must control the lift from this point by applying resistance on the back guy wires.* Resistance is provided by clipping a carabiner/rope assembly (shown in the photograph below) onto a back guy wire and providing a constant pull force at a distance away from the tower. Three (3) sets of carabiner/ropes are provided with the ginpole kit, one each for back guy wires #2, #4 and #6.



Picture 4-12: Rope for holding back guy wires



Continue the lift by powering the winch while at the same time (3) three technicians keep an even, strong hold of the back guy wires using the provided ropes. It is far easier to walk towards the tower while keeping tension on the rope than it is to try and let out rope while keeping constant tension. Do not completely remove slack in back guy wires by running the winch too long. If any of the 6 back guy wires become tight before the tower is vertical, then provide slack to the back guy wire from the anchor point before continuing the lift. Continue the lifting process until the **top** of the tower is directly over the base (sight with a carpenter's level).



Avoid winching in too much cable (to the point where the pulleys collide). If the pulleys are winched tightly together, the winch cable can break, causing total loss of tower control. Please note that the winch's motor has a slightly delayed response after the switch is released, and while coasting to a stop, may produce enough force to break the winch cable.

When the tower is vertical, before straightening, re-check that the tension in the back and side guy wires are set correctly to about 68 kg (150 pounds) of tension, allowing some slack in each guy wire. Check that wire rope clips are secure. Check that the winch free spool mechanism is securely covered with the safety mechanism and can't be accidentally released.

#### **4.4.3 Use of Back Stay Tension System while raising the 60m XHD TallTower.**

For installer's who own the Back Stay Tension System used in the NRG 80m TallTower lifting process, it is now an option to use on the 60m XHD tower. See [Appendix T](#) for the full procedure.



## 4.6 Transfer Lifters

Next, transfer the lifting guy wires one at a time from the ginpole to their respective anchors. Secure each lifter guy wire with wire rope clips. Remember that while the lifter is disconnected, you will be holding the tower! **Maintain tension while transferring the guy wires.**

As mentioned before, it is normal to have the tower bowed slightly away from the winch. As you transfer the lifters, you may have to add a little slack to the middle level back guy wires to allow the tower to straighten.

A lifter transfer hoist is supplied with the ginpole to make the task of transferring lifter wires from the ginpole to the front anchors easier than ever.

Secure the hoist to the ginpole coupler plate with the supplied hardware. To start, use the inner (closest to ginpole) hole on the coupler plate. Once secure, release the hoist brake and pull the hoist wire claw out. Secure the hoist wire claw to the swage on the upper lifter (green) just above the ginpole.



Picture 4-12: Secure the hoist to coupler plate



Picture 4-13: Extend hoist cable to lifter swage

Once the lifter is properly hooked, actuate the hoist by cranking the handle to increase tension in the hoist cable. You will see the portion of the lifter between the ginpole and the swage hook go slack.

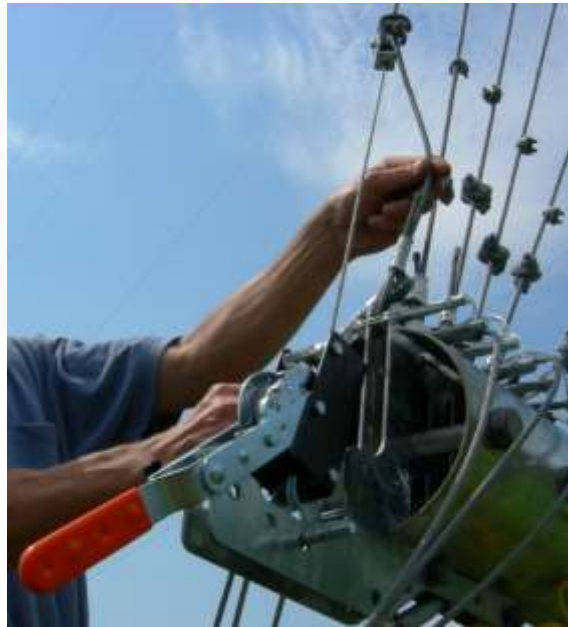

**Picture 4-14 & Picture 4-15: use hoist to loosen lifter to remove from ginpole**

When it appears that the lifter is sufficiently loose, remove the pin from the ginpole and unhook the hoist from the swage on the lifter.



**Picture 4-16: Remove thimble from Pin**



**Picture 4-17: Remove hoist claw**



Walk the lifter back to the front anchor point and secure. Remember to maintain tension on lifter throughout this process, especially if there is wind blowing toward the tower from the direction of the winch.

Working downward, transfer each of the guy wires one at a time to their respective anchors. To straighten the tower, adjust the back guy wires as the lifters are transferred. Be sure to correctly identify to which anchor each guy wire should be attached (refer to appropriate drawing in the appendix section). When you reach the lowest lifter (red), move the lifter transfer hoist to the outermost coupler plate hole for better alignment of the pull direction.





## 4.7 Plumb and Straighten

Make final adjustments to the guy wires. Using a carpenter's level or inclinometer on the base tube, adjust the lowest level guy wires as needed so the base tube is vertical. Working upward, adjust all four guys at each level while sighting up the tower from the base to straighten the tower (see picture 4-18 below).



**Picture 4-18: Plumb & Straighten**

As you finalize the straightening of the tower, you will also need to set the final tension on the guy wires.

## 4.8 Guy Tension Check

We recommend two (2) techniques outlined in ANSI/TIA-222-G to more accurately set guy wire tensions to ensure they are consistent and match well with the tensions assumed during the tower structural analysis. The two (2) methods described below are:

- Pulse Method
- Tangent Intercept Method

### 4.8.1 Pulse Method

The pulse method is as follows:

- Apply a sharp jerk to the guy wire above its anchor point (just above the wire rope clips). You may need to remove the guy guard to access the wire rope. The jerk to the guy wire will transmit a pulse along the wire (you can see the pulse visually, and, if holding loosely onto the wire rope, you can feel it in your hand when the pulse returns down the wire). Coincide with the applied jerk, start your stopwatch. Your stopwatch should be capable of measuring time to within a 1/10th of a second.
- Measure the time it takes the pulse to travel up and back down, twice (N = 2 pulses).



- Repeat the Pulse Method three (3) times and record the average value.
- Verify the average measured pulse time is within the allowable range as shown in Table 4-2
- If necessary, adjust the guy wire tension per the section entitled *Adjusting Guy Wires*.

**Table 4-1: Guy Tensioning per the Pulse Method (During Tower Erection) N=2 pulses**

Guy Level	N (# of pulses)	Minimum Time (sec)	Maximum Time (sec)
1 (Lower)	2	2.3	3.2
2	2	2.5	3.3
3	2	3.0	4.2
4	2	3.3	4.5
5	2	3.6	5.4
6	2	4.0	5.9

**Table 4-2: Guy Tensioning per the Pulse Method (During Tower Erection) N=1**

Guy Level	N (# of pulses)	Minimum Time (sec)	Maximum Time (sec)
1 (Lower)	1	1.3	2.0
2	1	1.5	2.0
3	1	1.5	2.5
4	1	2.0	2.5
5	1	2.0	3.0
6	1	2.0	3.0

**Table 4-3: Guy Tensioning per the Pulse Method (Tower Erect at 90°) N=2**

Guy Level	N (# of pulses)	Minimum Time (sec)	Maximum Time (sec)
1 (Lower)	2	2.2	2.7
2	2	2.5	3.0
3	2	3.0	3.5
4	2	3.1	3.7
5	2	3.8	4.4
6	2	4.0	4.7

For ease of measuring and efficiency of checking the tension of all (6) six levels of guy wires during the lifting process, measuring with the Pulse Method using 1 pulse (N=1) is acceptable. The chart below shows in green the optimal tension that you want to achieve for each level during the tower erection. The seconds counted for a single pulse (up to the guy ring and back to your hand) should equal the seconds shown on the top line of the chart for each level. Charts for using 2 pulses (N=2) are also shown below for during the lifting process and final tension when the tower is vertical.



**Table 4-4: Guy Tensioning per the Pulse Method (During Tower Erection) N=1 Pulse**

		During Tower Erection							
		Tension (lbf) for Pulse Times (sec)							
Guy Level	N (# of pulses)	6	5	4	3	2.5	2	1.5	1
6	1	23	34	53	94	135	211	374	842
5	1	19	28	43	77	111	173	308	693
4	1	15	21	33	58	84	131	233	523
3	1	12	18	28	49	71	111	197	442
2	1	9	13	20	35	51	79	141	317
1 (Bottom)	1	7	10	16	29	41	65	115	258

**Table 4-5: Guy Tensioning per the Pulse Method (During Tower Erection) N=2 pulses**

		During Tower Erection															
		Tension (lbf) for Pulse Times (sec)															
Guy Level	N (# of pulses)	6	5.8	5.2	5.1	5	4.7	4.4	4.3	4	3.8	3.3	3.1	3	2.8	2.5	2
6 (Top)	2	94	100	125	130	135	153	174	182	211	233	309	351	374	430	539	842
5	2	77	82	103	107	111	125	143	150	173	192	255	288	308	354	444	693
4	2	58	62	77	80	84	95	108	113	131	145	192	218	233	267	335	523
3	2	49	53	65	68	71	80	91	96	111	123	162	184	197	226	283	442
2	2	35	38	47	49	51	57	65	68	79	88	116	132	141	162	203	317
1 (Bottom)	2	29	31	38	40	41	47	53	56	65	71	95	107	115	132	165	258

**Table 4-6: Guy Tensioning per the Pulse Method (Tower Erect at 90°) N=2 pulses**



		Tower Erect at 90°													
		Tension (lbf) for Pulse Times (sec)													
Guy Level	N (# of pulses)	5	4.9	4.7	4.4	4.3	4	3.8	3.6	3.3	3.1	3	2.8	2.5	2
6 (Top)	2	135	140	153	174	182	211	233	260	309	351	374	430	539	842
5	2	111	115	125	143	150	173	192	214	255	288	308	354	444	693
4	2	84	87	95	108	113	131	145	161	192	218	233	267	335	523
3	2	71	74	80	91	96	111	123	137	162	184	197	226	283	442
2	2	51	53	57	65	68	79	88	98	116	132	141	162	203	317
1 (Bottom)	2	41	43	47	53	56	65	71	80	95	107	115	132	165	258

### 4.8.2 Tangent Intercept Method

The basis for the Tangent Intercept Method of verifying guy wire tensions is a visual “sighting” technique shown in the picture below.

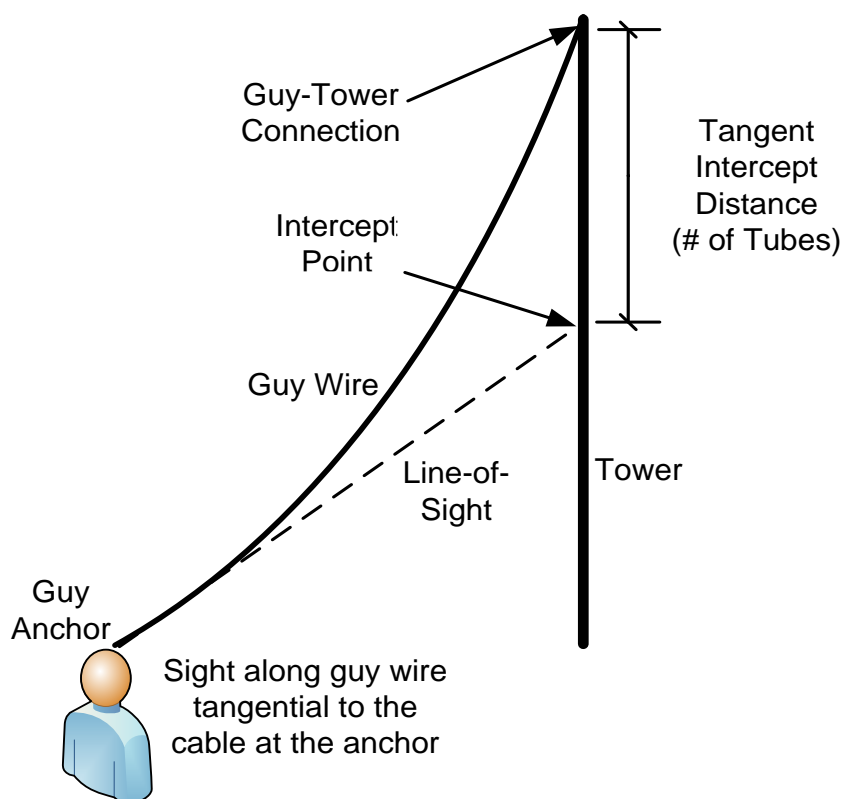

Figure 4-1: Tangent intercept method



Sight along the guy wire, tangential to the cable at the anchor point. Extend the line-of-sight until it intersects the tower. The tangent intercept is the distance between the guy-tower connection and the intersection of the line-of-sight with the tower. This tangent intercept distance is measured in terms of the number of tower tubes and is directly related to the guy wire tension.

As an example, Picture 4-19 shows a view of the Level 1 guy wire from near the ground up toward the guy ring. If you look closely, you will note that the projected line of the lower portion of the guy intersects the tower at about one tower tube below the Level 1 guy ring (visible just above the ribbon). This represents a “guy sag” of “1-1/4 tubes”. Picture 4-20 shows the same guy wire somewhat looser. In this case, the guy wire appears to intersect about 2-½ tower tubes below the guy ring (guy sag = 2.5 tubes). In both cases, the guy wires were adjusted by two people without the use of tensioning devices.



**PROPER GUY WIRE TENSION IS CRITICAL. FAILURE TO ENSURE PROPER GUY WIRE TENSION CAN CAUSE A FAILURE OF THE TOWER, GUY WIRES OR GUY ANCHORS RESULTING IN SERIOUS INJURY, DEATH OR PROPERTY DAMAGE. ONCE LIFTED, ALWAYS READ AND FOLLOW INSTRUCTIONS FOR MEASURING AND REACHING PROPER GUY WIRE TENSION.**



**Picture 4-19: Level 1 Guy, Sag = 1.2 Tube (Acceptable)**





**Picture 4-20: Level 1, Guy Sag = 2.6 Tubes (Too slacked)**

Using this sighting technique, adjust guy tensions to fit within the limits shown in Table 1 below.

**Table 4-7: Guy Tensioning**

Guy Level	Guy Slack Range (# of Tubes below Guy Ring)	
	Least Sag	Most Sag
1	1	2
2	1.5	2.5
3	2	3
4	2.5	3.5
5	3	4.5
6	3.5	5

As an example, for Level 1, the least sag the guy wire should have is 1 tube; the most sag is 2 tubes. Therefore, the guy wire in Figure 1 meets the requirement, and the guy in Figure 2 is too loose.

#### **4.9 Final Inspection and Maintenance**

Using the preferred pulse method to guy wire tension, double check that all guy wires meet the specification while keeping the tower straight/plumb. Tighten all wire rope clips on each guy wire now, with about 100 mm to 200 mm (4 inches to 8 inches) between clips. Re-check that all wire rope clips are tight. Final torque on wire rope clips should be 16 Nm (12 ft-lb) for 1/4 inch wire rope clips. The ginpole may be left in place, or it may be removed and disassembled if desired. If using guy guards, attach one to each guy wire and one to the winch anchor as shown below.



Picture 4-20: Guy Guard attachment



Picture 4-20: Guy Guard on winch anchor

Check the tower in 2 or 3 weeks, tighten loose guys and straighten the tower if needed. It is especially important to do this before any icing events occur. Also check the guy wires after any severe ice or wind storm. Some settling of the tower or anchors may occur, and guy wires can stretch. Loose guy wires can also result when the wire rope clips securing the guys are forced down by the impact of sliding ice.



**WARNING** MAINTAINING PROPER GUY WIRE TENSION IS CRITICAL. FAILURE TO MAINTAIN PROPER GUY WIRE TENSION AFTER INSTALLATION CAN CAUSE A FAILURE OF THE TOWER, GUY WIRES OR GUY ANCHORS RESULTING IN SERIOUS INJURY, DEATH OR PROPERTY DAMAGE. AFTER INSTALLATION, IT IS IMPORTANT TO CHECK GUY WIRE TENSION PERIODICALLY AND ENSURE PROPER TENSION MEASUREMENTS ARE MAINTAINED. ALWAYS READ AND FOLLOW INSTRUCTIONS FOR MAINTAINING PROPER GUY WIRE TENSION.

## 4.10 Snap Through

One of the most important reasons for good tower maintenance, particularly guy tension maintenance, is to avoid a form of tower failure known as “Snap-Through.” Snap-Through typically occurs when the guys are allowed to become loose, and a high wind is blowing on the tower. Even in normal conditions, the upper guys work at a narrower angle to the upper tower than the lower guys, reducing their effectiveness at restraining sideways bending (see figure below). If the guys are allowed to become loose, the working angle is further decreased. If the loads are high enough, or the guys are too loose, the angle between the guy and the tower will reduce to zero, and the guy can no longer restrain the sideways motion. The result is that the upper tower “snaps through” and falls over.

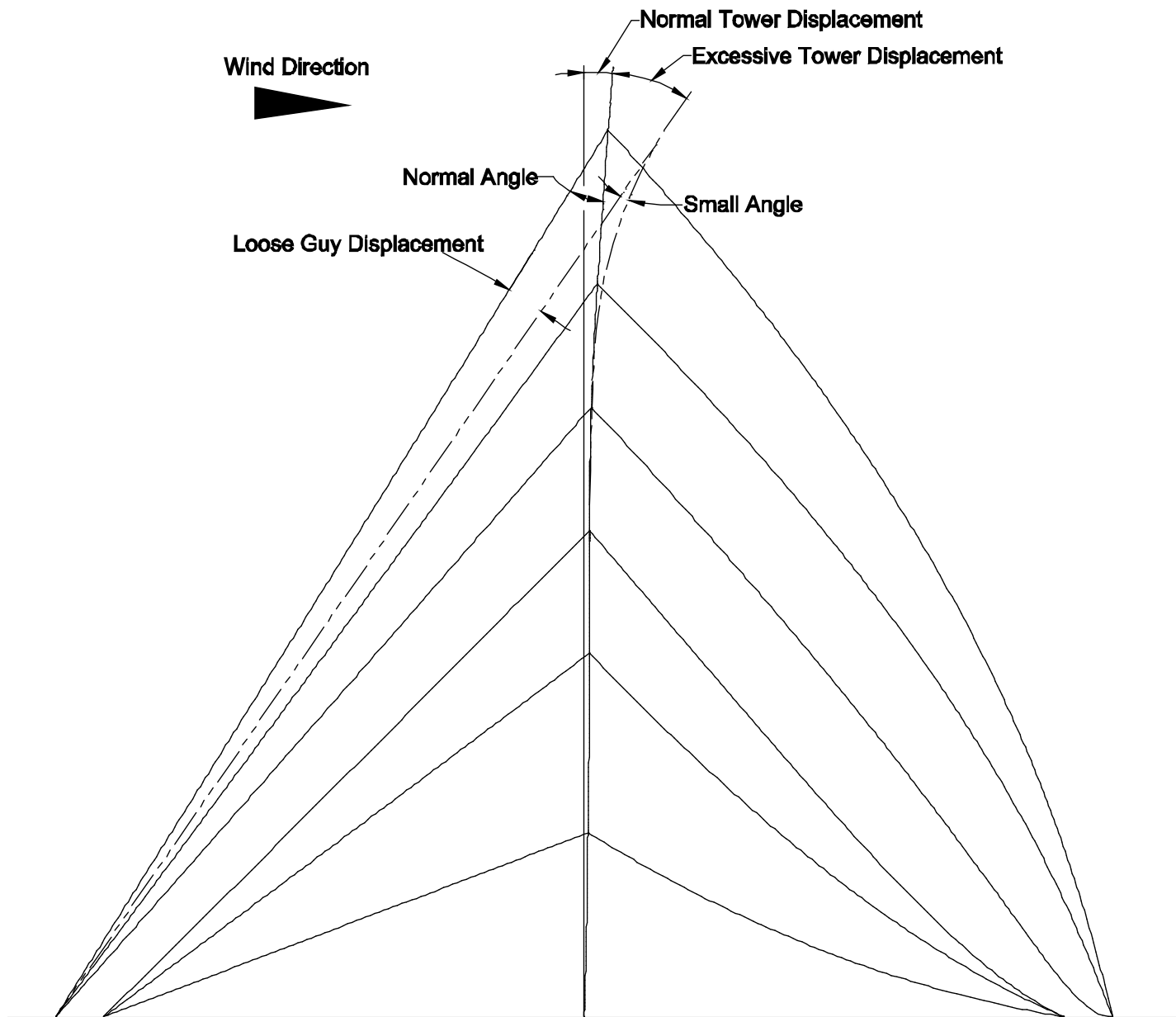

Figure 4-2: Snap-Through diagram



## 4.11 Tower Lowering

Lowering the tower is the reverse of raising the tower, though there are a few additional precautions to be taken. Just as side guy wire tension may vary during the lifting process, the same is true as the tower is lowered. Side guy wires will have to be tended in order to maintain proper guy tension.

If the tower is to be lowered onto blocking, place the blocking now while it is still safe to work under the tower. If the ginpole was removed, set up the ginpole as described previously. Remember that the extensions of the coupler plate will now be facing the ground. Using the lifter transfer hoist, lift the ginpole and transfer the lowest level lifting guy wire from the anchor to the ginpole. Remember that you will be holding the tower: maintain tension while transferring the wires. Winch in or out as needed to maintain the correct amount of tension in the guy wire when it is transferred. ***The winch cable must always spool and unspool from the bottom of the cable drum in order for the winch brake to work properly.***

Transfer the lifter guy wires from the anchor to the ginpole, in order from lowest to highest. Tension must be applied to the back guys to pull the tower away from the winch as you begin lowering. This keeps wind loads and/or the weight of the ginpole from suddenly pushing the tower back upright, which could cause guy wire or anchor failure. Leave the guy wire attached to the anchor and pull outward on the guy wire to take out the slack. The safest way to do this is by attaching the supplied rope around the back guy wires and pulling to the side. This allows the crew members to maintain tension by hand without being under the tower.

Maintain tension on a minimum of one mid-level and one top level guy wire during lowering. Use two crew members to tend the two top level and the two mid-level guy wires. These crew members should maintain tension in the back guys and take up the slack in the guy wire as the tower lowers toward them.

As the tower is lowered and reaches an angle of between 75 and 60 degrees, it will no longer be necessary to maintain tension on the back guy wires. Stop the winch at least as often as each 20 degrees to re-check side guy wire tension and to allow the winch to cool for a minute.

The force on the winch is greatest as the tower nears the ground. Be sure to stand to either side of the winch cable and behind the winch, batteries, and power cables rather than directly in line with it.

To lower the ginpole, put the helper ginpole in place. As the ginpole nears the ground, place the winch cable (all three strands) in the 3 pulleys on the top of the helper ginpole. The pole can then be lowered to the ground.



## NOTICE

**ALWAYS MAINTAIN PROPER TENSION ON GUY WIRES DURING THE LOWERING PROCESS, ESPECIALLY WHEN THE TOWER IS BETWEEN 90° AND 85°. FAILURE TO MAINTAIN PROPER GUY WIRE TENSION CAN CAUSE DEFORMATION OR OTHER DAMAGE TO THE TOWER. ALWAYS READ AND FOLLOW LOWERING INSTRUCTIONS FOR INCREMENTAL LOWERING AND CAREFULLY UTILIZE THE “INCH-WORM” METHOD SET FORTH IN THE INSTALLATION MANUAL.**

## Appendix A: Tower Selection

The following graphs allow you to select the best tower configuration to meet local EIA-222-F requirements. To use the graphs, you will need to obtain wind and ice load requirements (available from your permitting agency). Using these two numbers, find the point at which they intersect on the graph and make sure that this point is below the line for the tower configuration you would like to erect. Please note that these graphs are based on the “fastest-mile” type of wind load specification. If local requirements specify wind loading as the “3-second gust”, you will have to approximate the fastest-mile value. Each graph has information on this conversion in the upper right corner.

**Caution:** Small footprint configurations have increased potential for snap-through failure when guy wire tensions have not been well maintained (see “Final Inspection and Maintenance” above).

The small footprint configuration also significantly increases side guy forces during erecting and lowering. Even experienced installation teams have been surprised by these forces. It is critical to keep the tower straight at all times. This is particularly important when the tower is near the ground where forces are at their greatest and most difficult to control. Use the standard footprint configuration whenever possible.

If installing the TallTower using a single anchor point configuration, use an anchoring system designed in accordance with predicted single anchor loads. If you are unsure of how to anchor your tower, seek professional guidance.



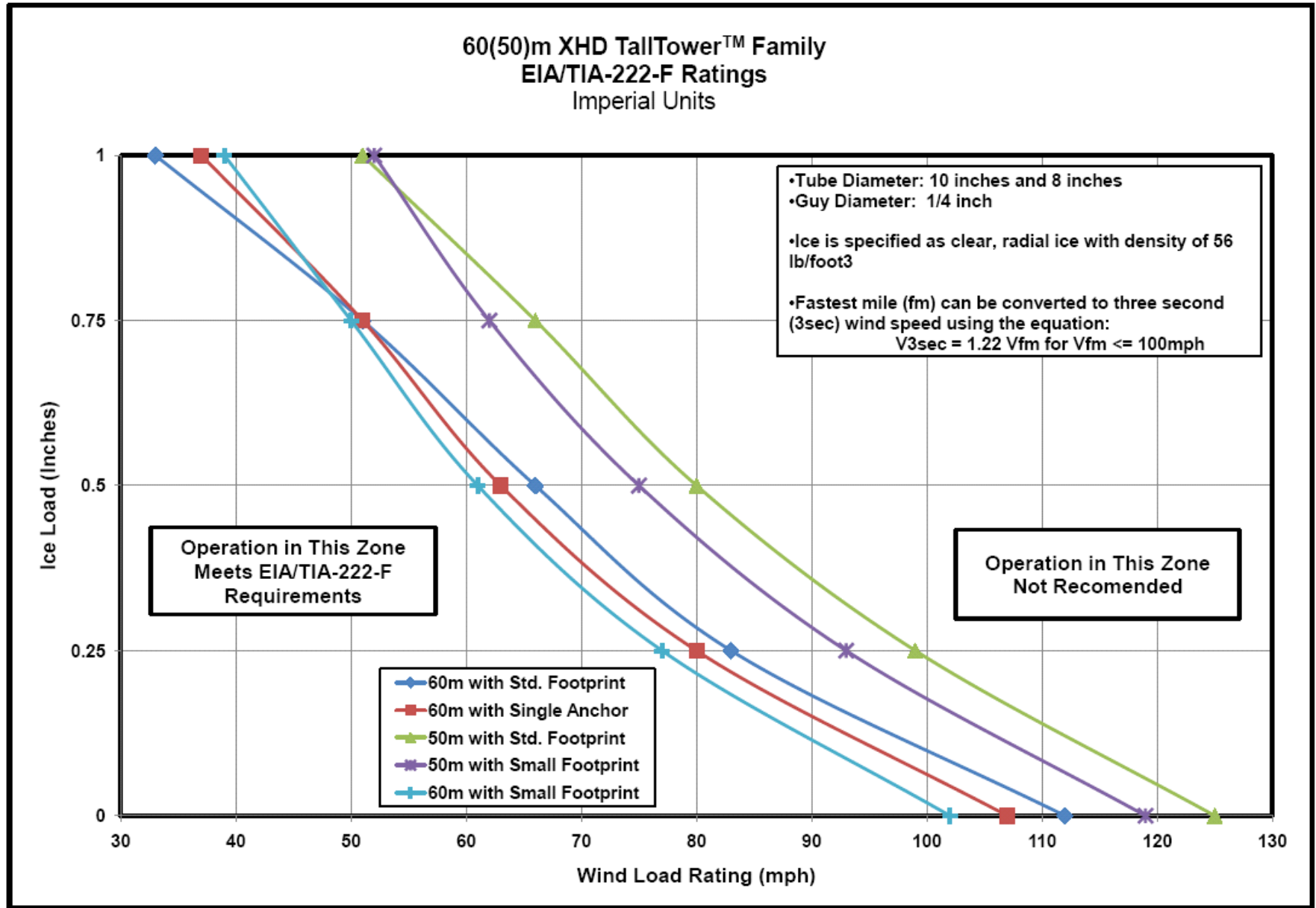

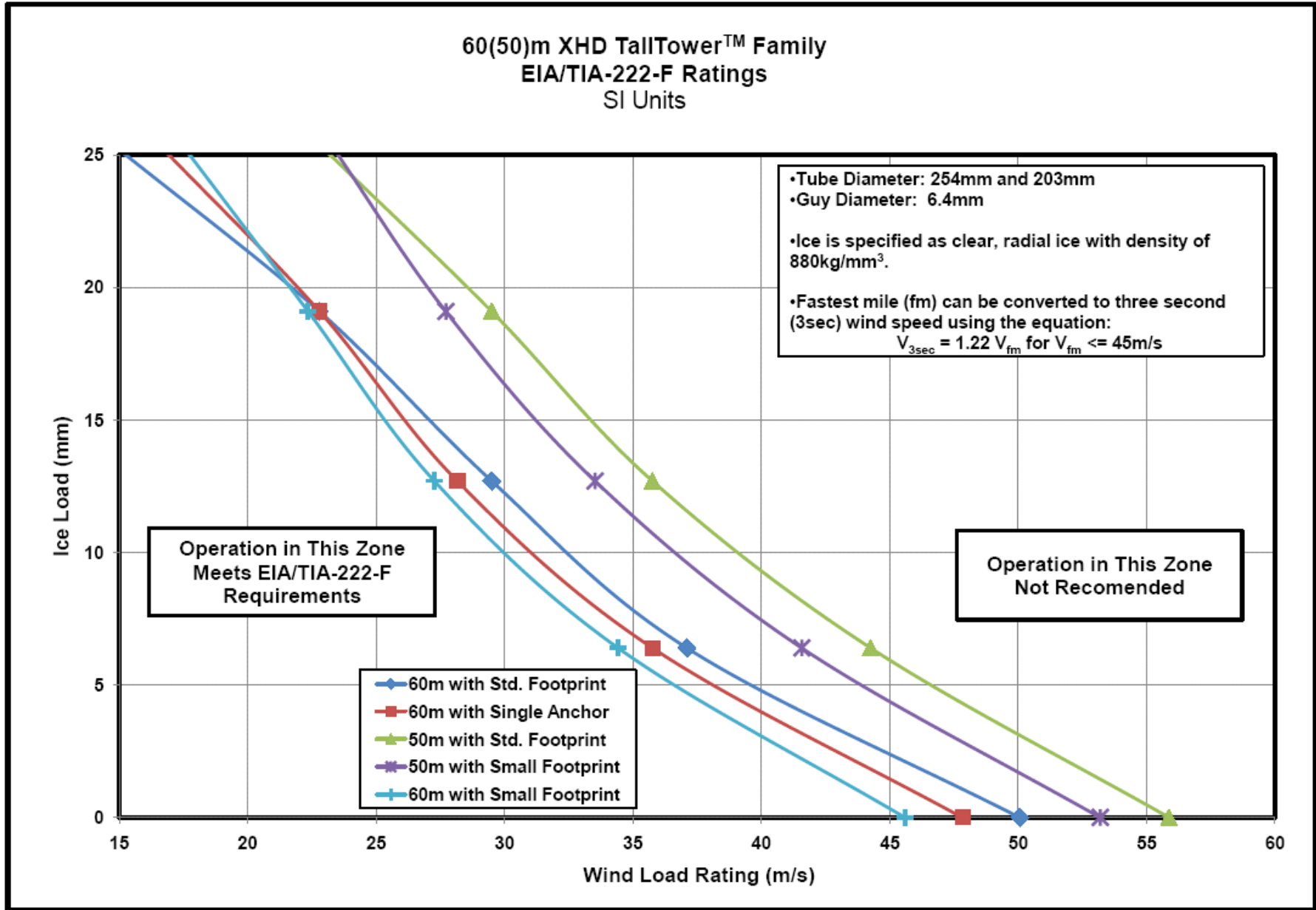

## Appendix B: 60m XHD with Standard Footprint

### Tower Layout

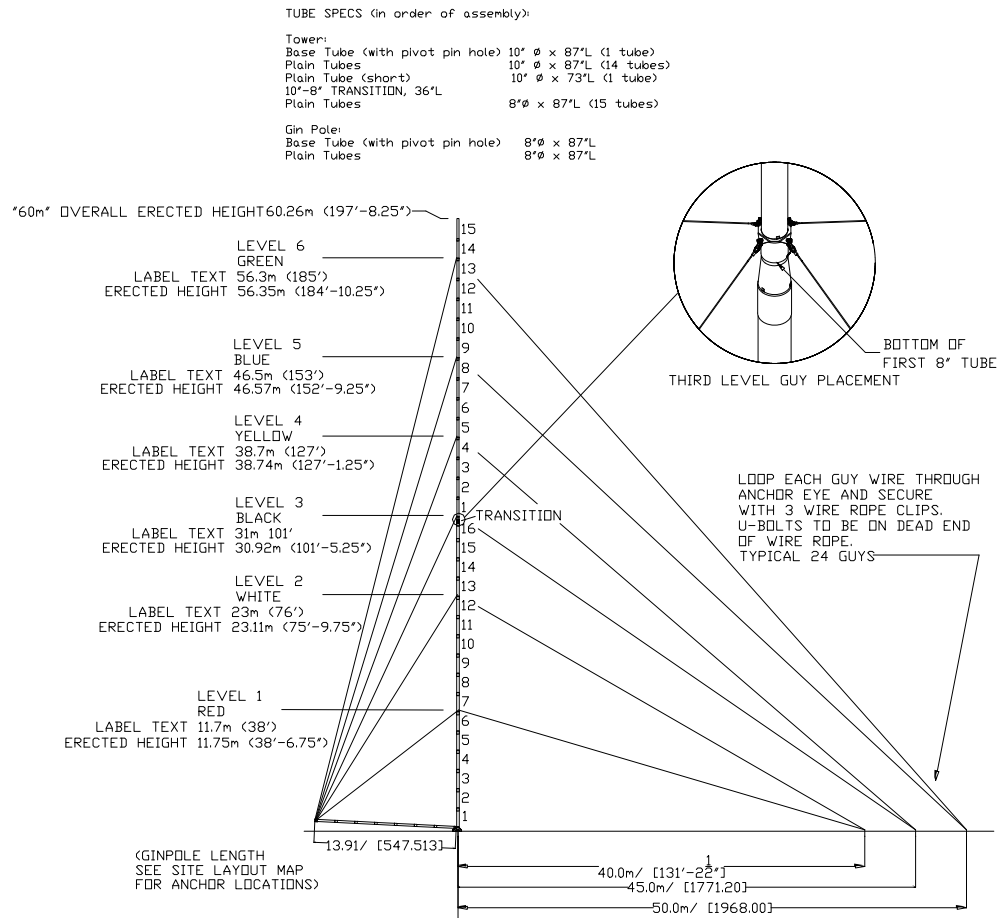

### Site Layout

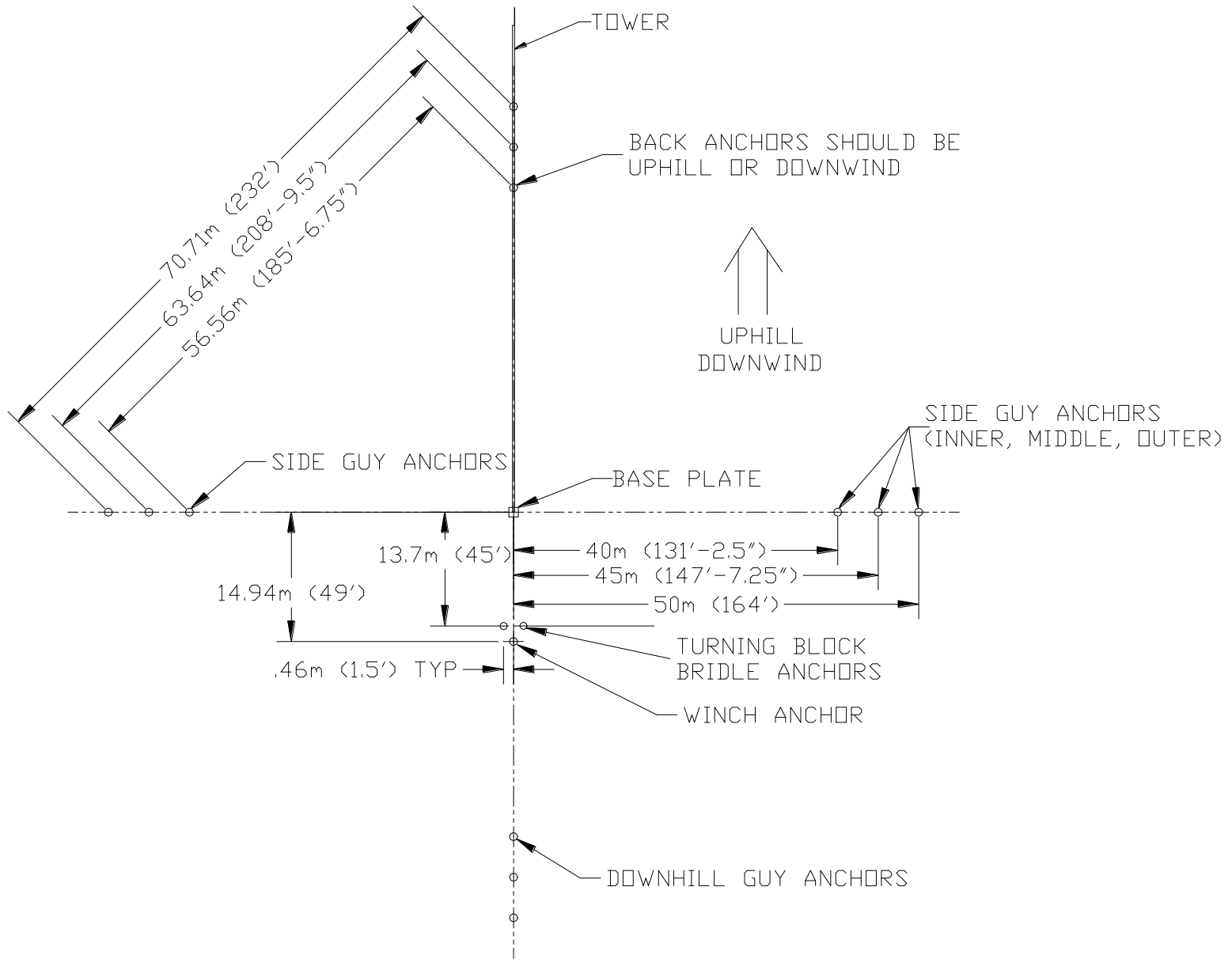

### Code Compliance Curve – Imperial Units

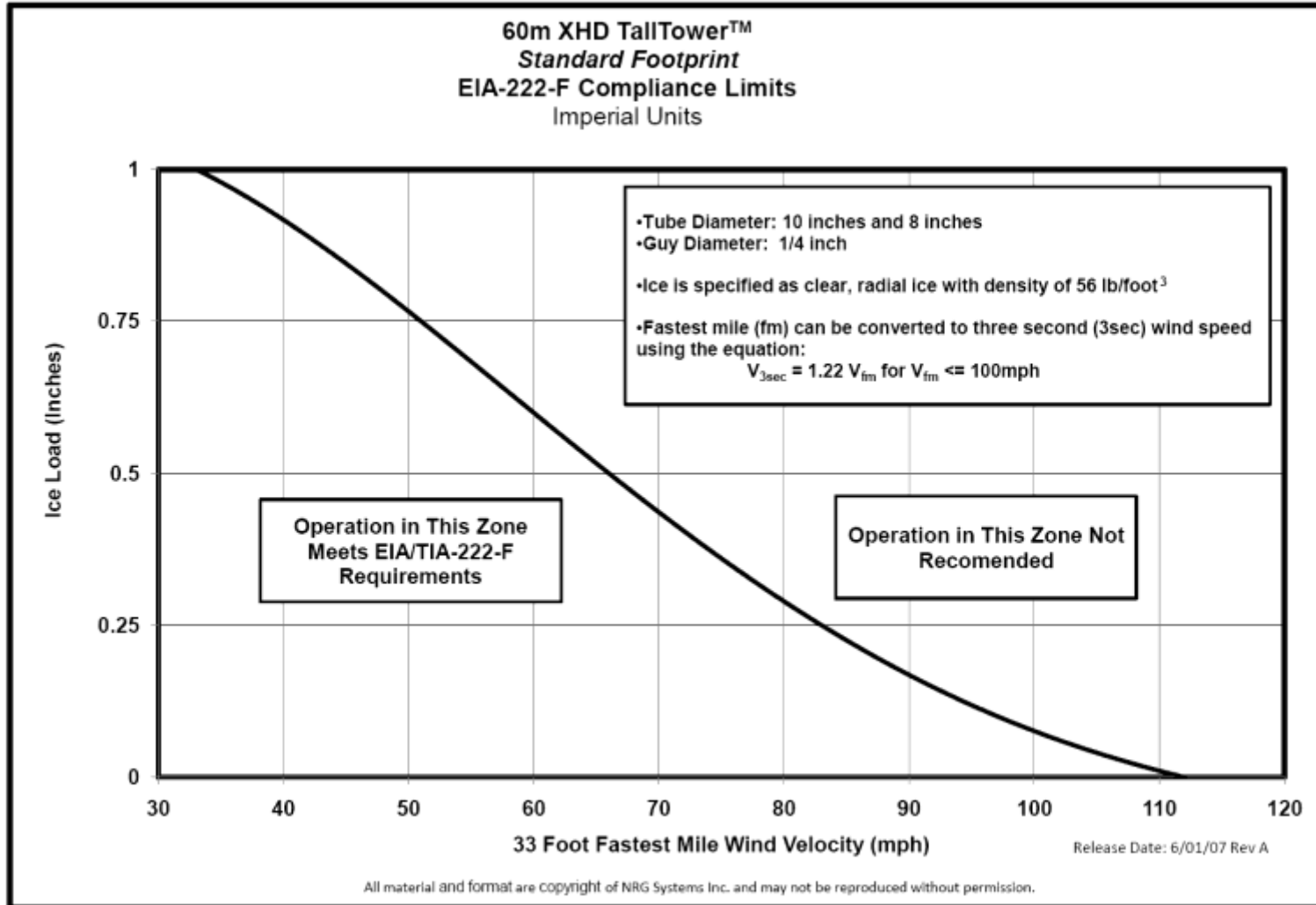



### Code Compliance Curve – SI Units

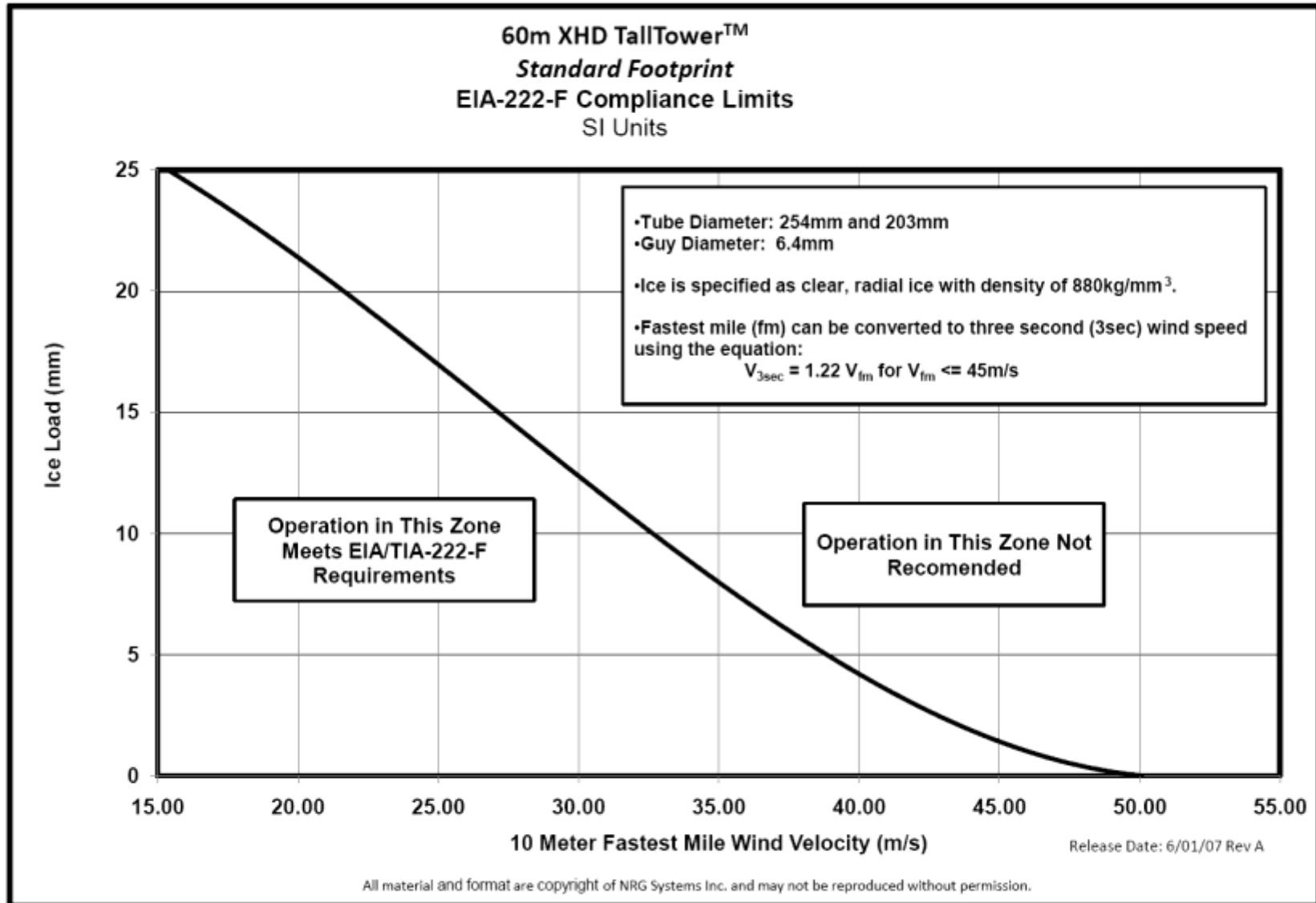

Stamped Drawing

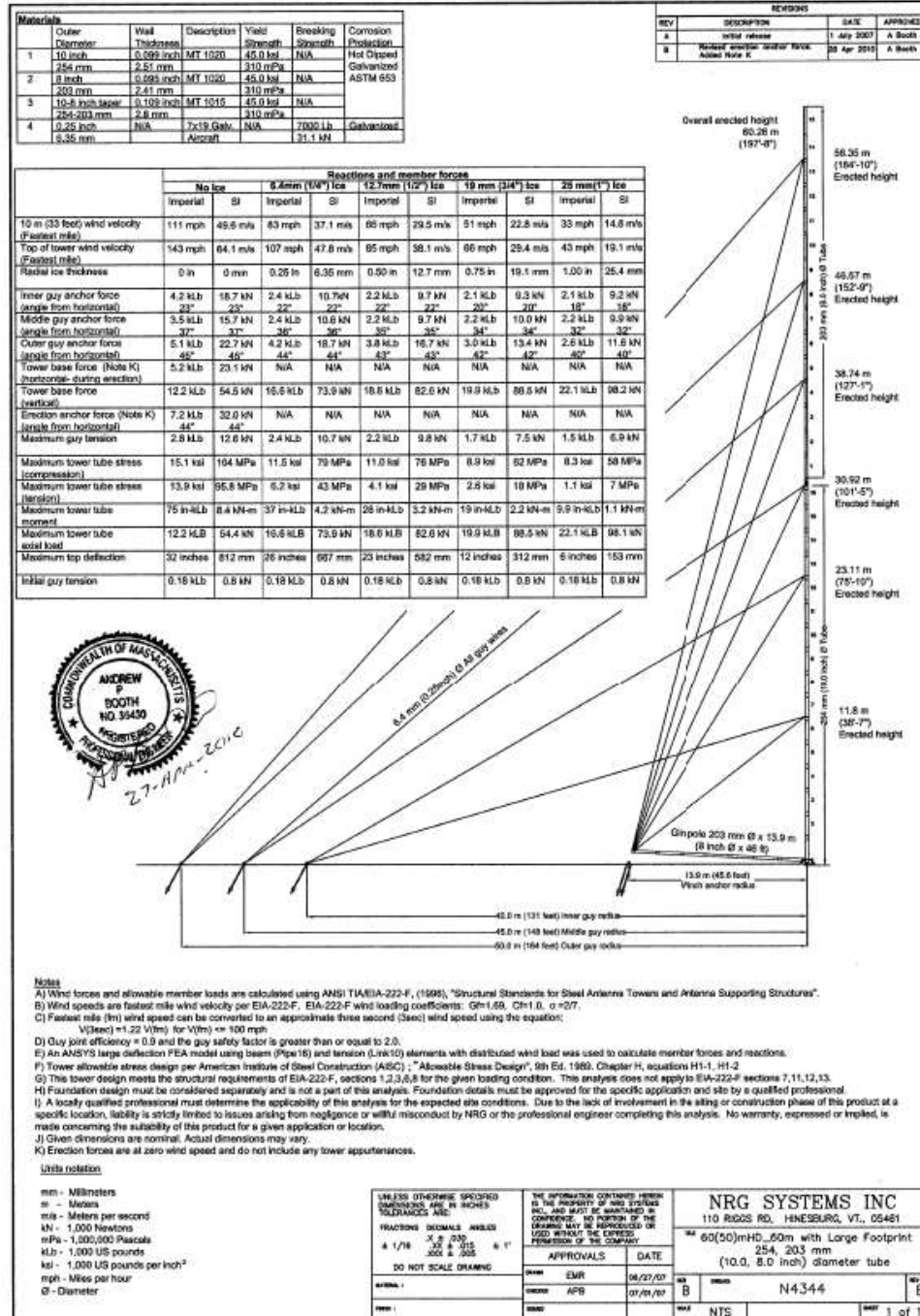

### Anchor Loads – Imperial Units

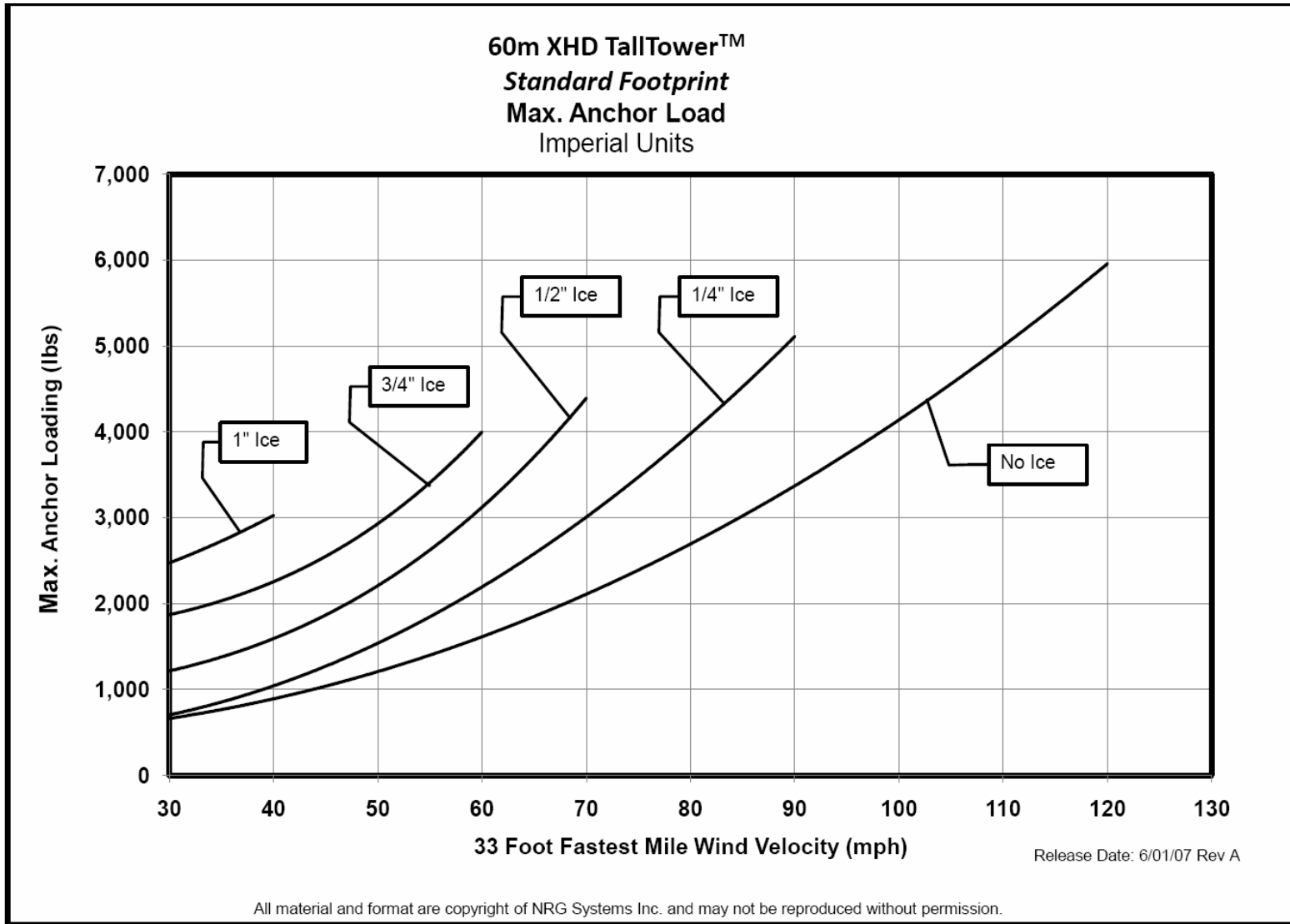

Anchor Loads – SI Units

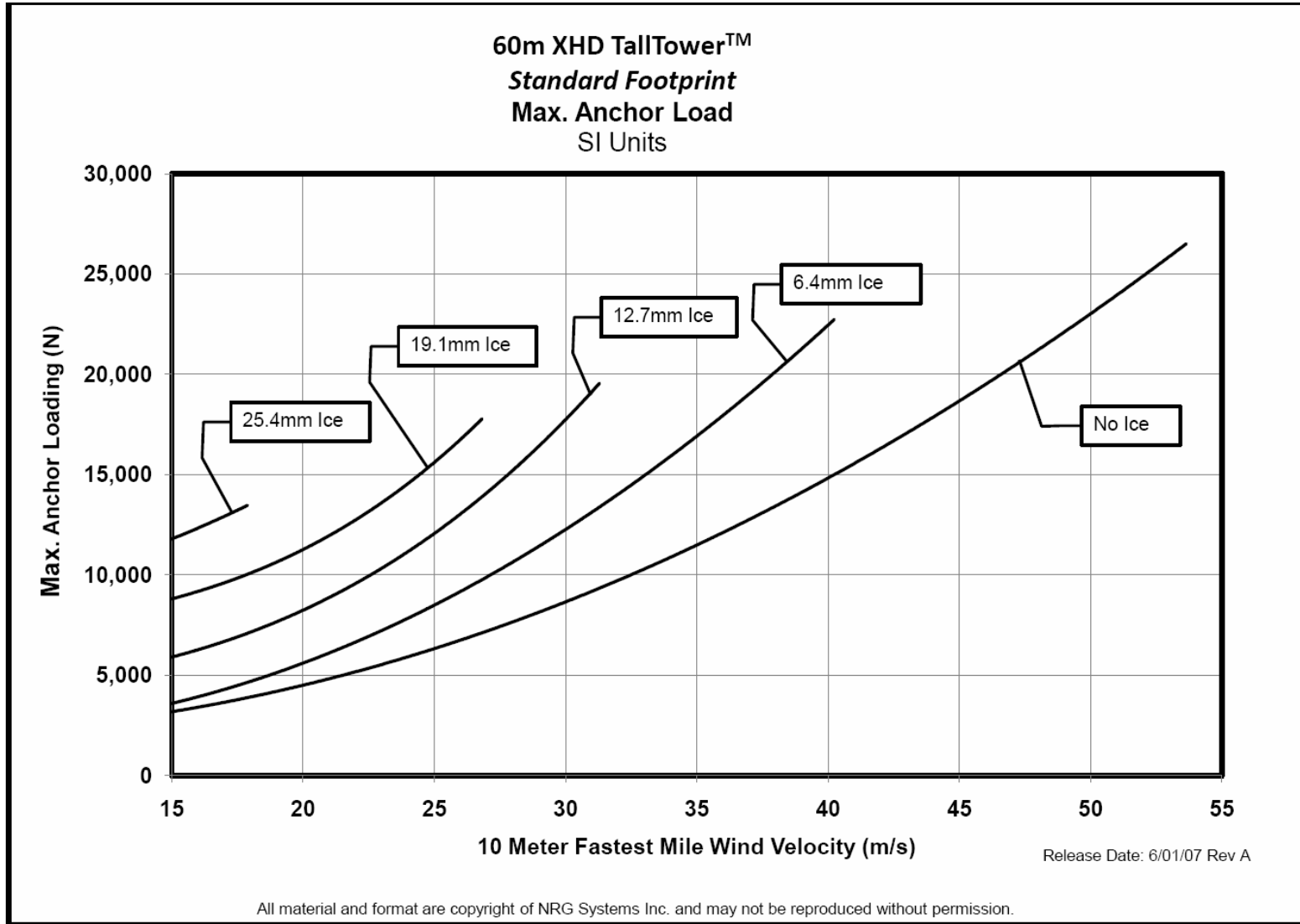

(The loads shown on the graph apply to each of the anchors) Baseplate Loads – Imperial Units

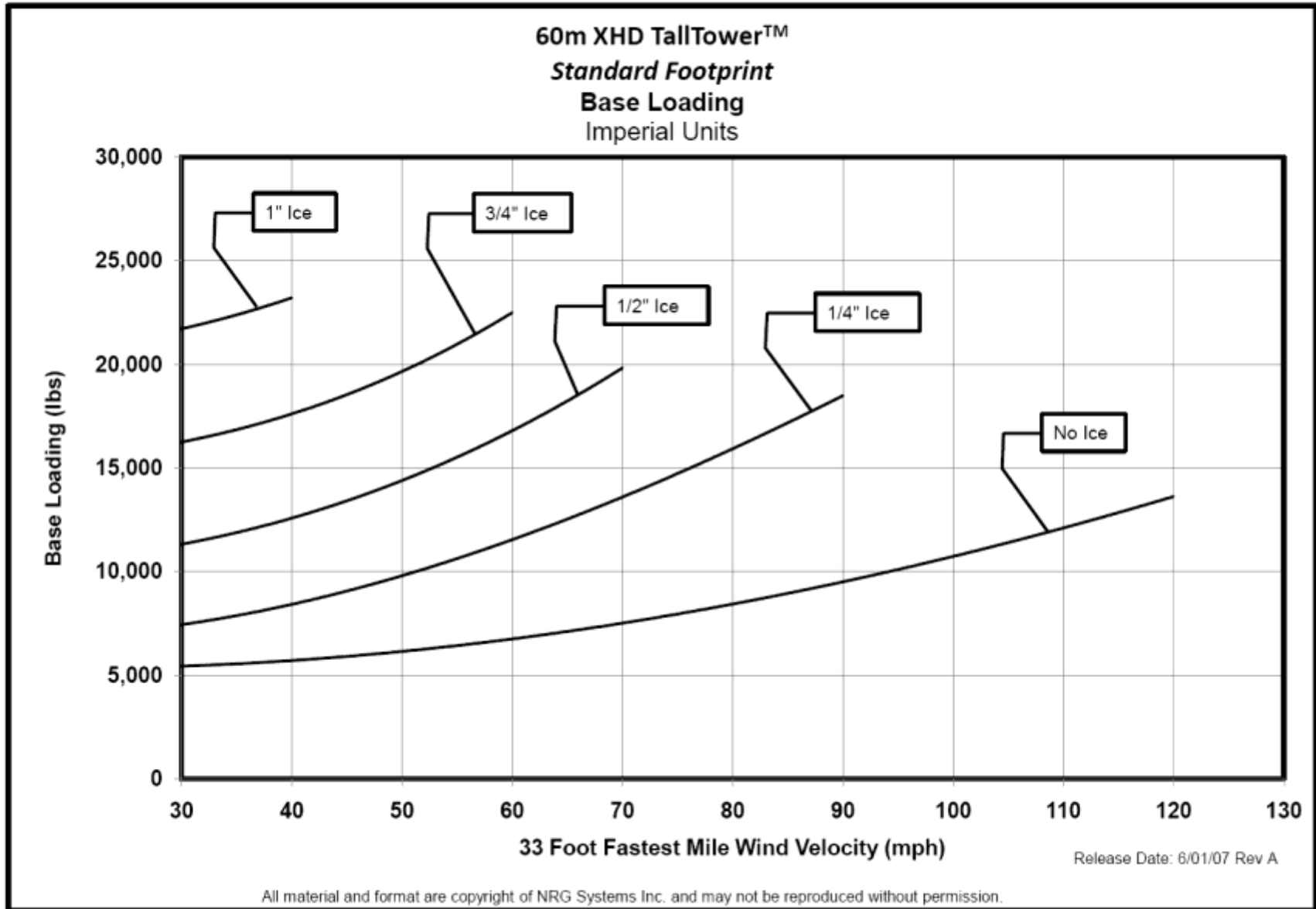



### Baseplate Loads – SI Units

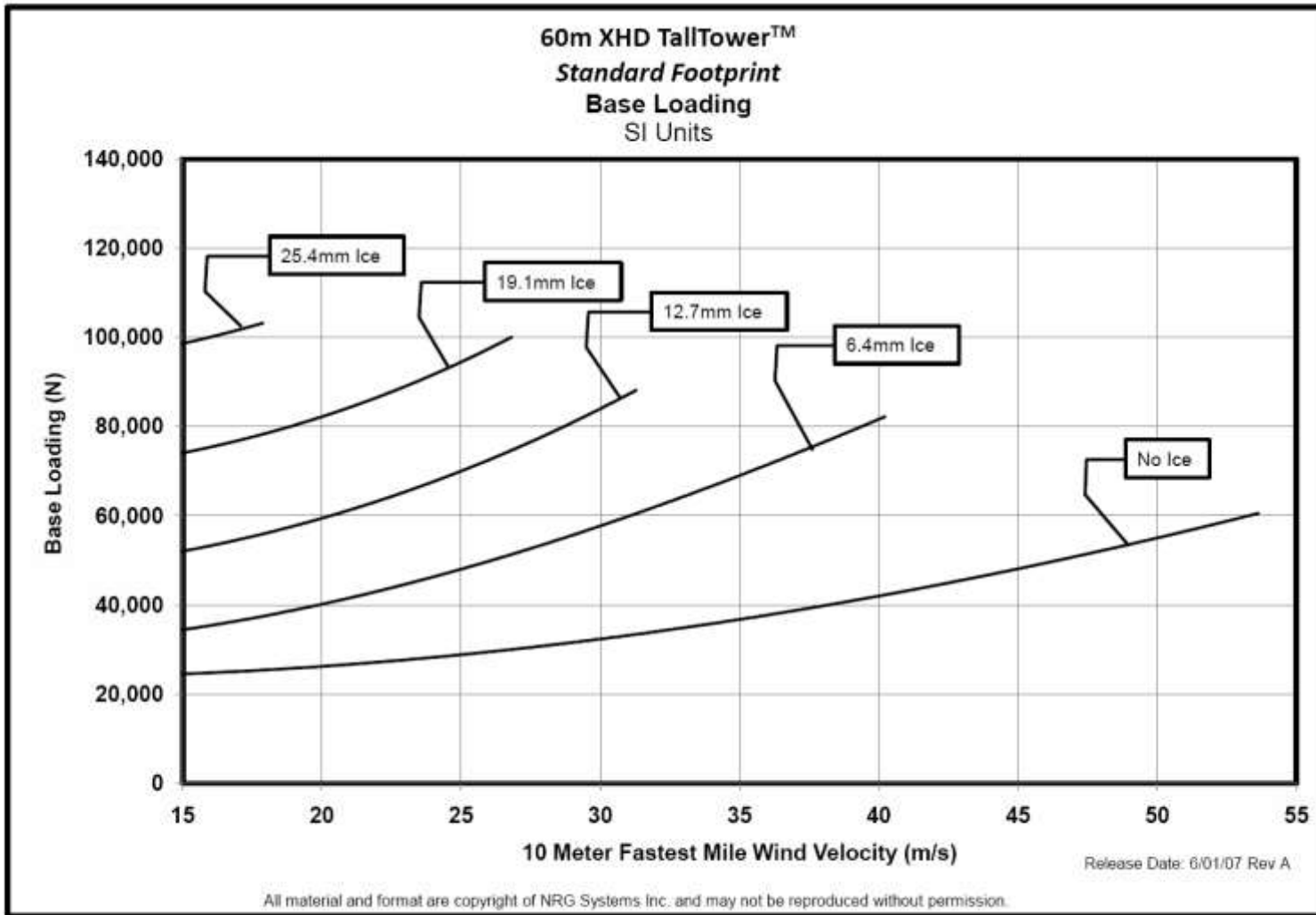

**Tower Erection Forces (tower only)**

EIA-222-F wind velocity	Horizontal base reaction	Winch anchor reaction (b)
0 m/s (0 mph)	23.1 kN (5200 lbs.) (a)	32.0 kN (7200 lbs) @ 44° from Horizontal Load spread between the 3 anchors or 10.7 kN (2400 lbs) per anchor

**Tower Erection Forces (with typical NOW System – 2 booms at 40 m, 3 booms at 50 m, 3 booms at 58 m, cables)**

EIA-222-F wind velocity	Horizontal base reaction	Winch anchor reaction (b)
0 m/s (0 mph)	25.8 kN (5800 lbs.) (a)	35.6 kN (8000 lbs) @ 44° from Horizontal Load spread between the 3 anchors or 11.9 kN (2667 lbs) per anchor

Notes:

- a) The maximum horizontal reaction occurs when the tower is just off the ground.
- b) Maximum force on the winch anchor during tower erection (occurs when tower is just above the ground).
- c) These values assume no safety factor.

## Baseplate Geometry

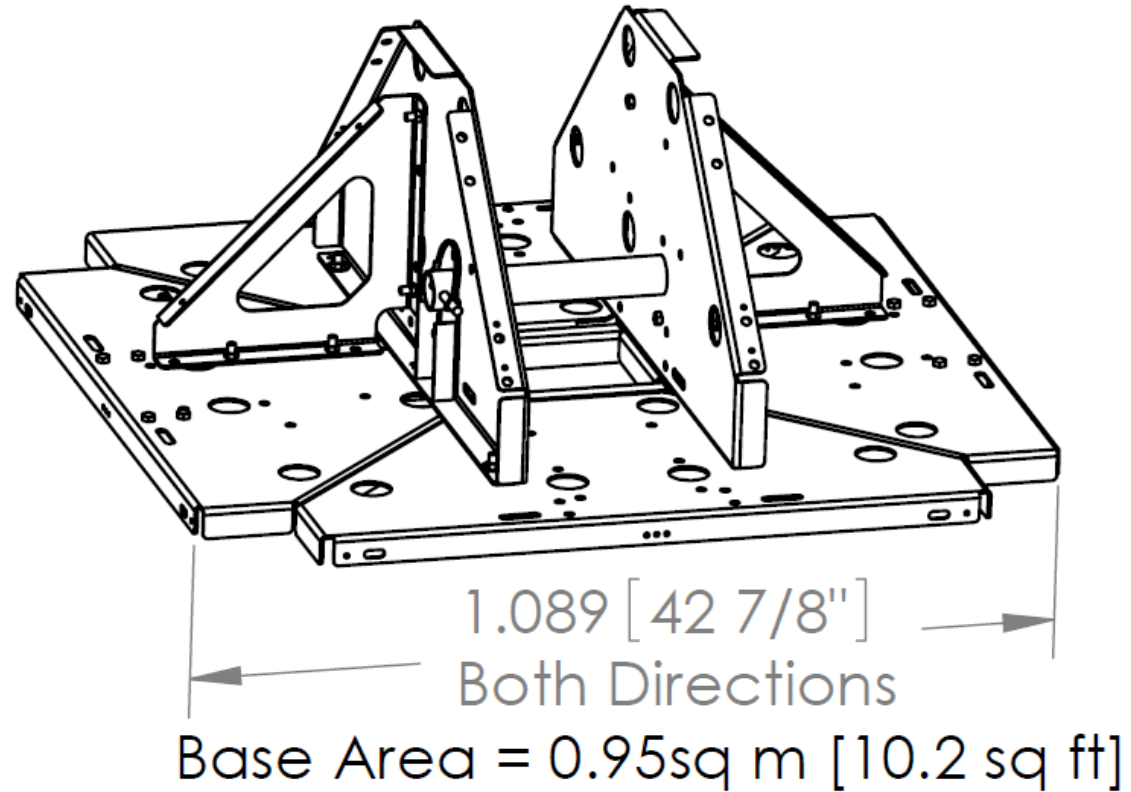

# 60m XHD Standard Footprint

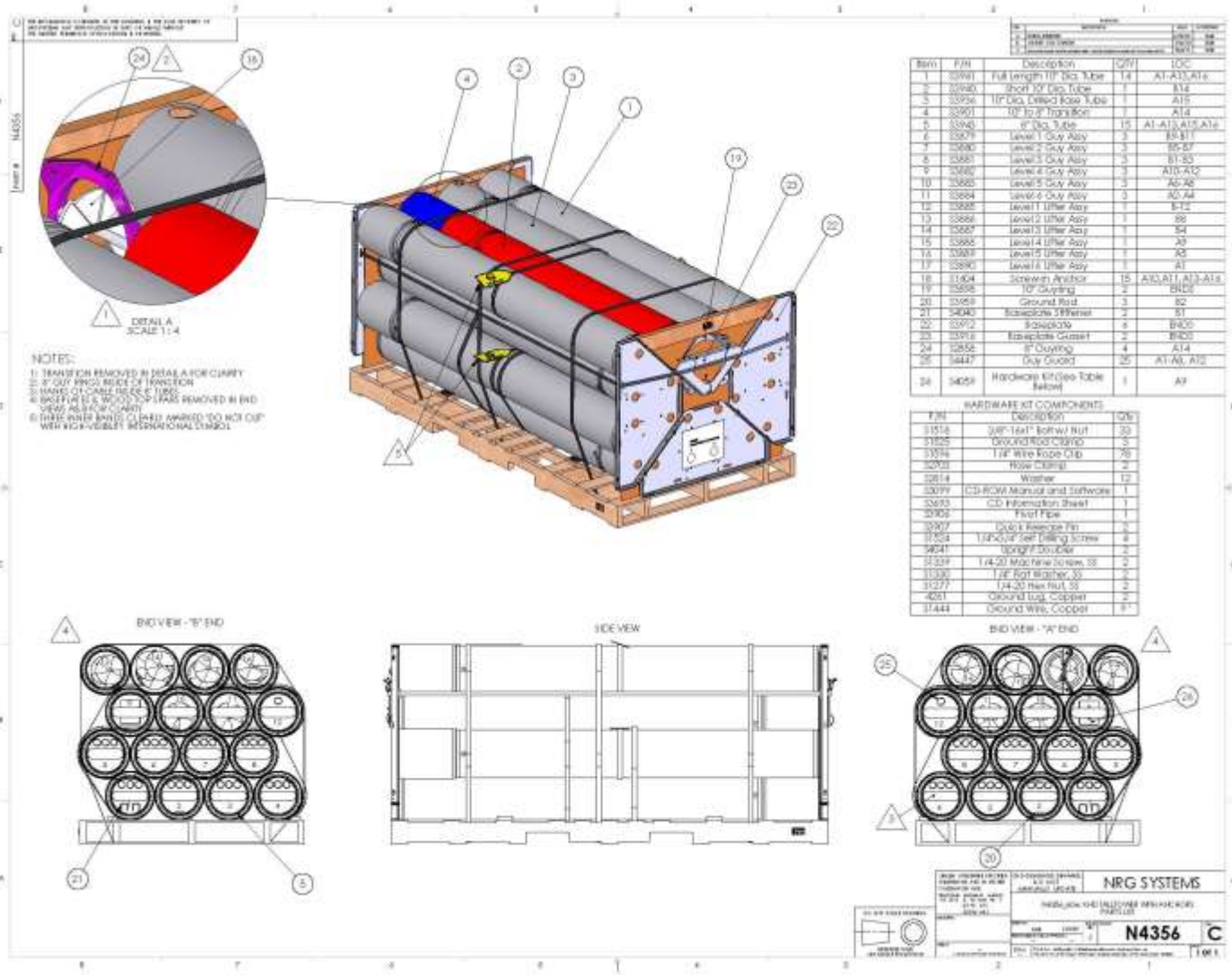

60m XHD: 2 Anchor  
Standard Footprint

## Appendix C: 60 m XHD 2 Anchor Standard Footprint: Tower Layout & Stamped Drawing



# 60m XHD: 2 Anchor Standard Footprint

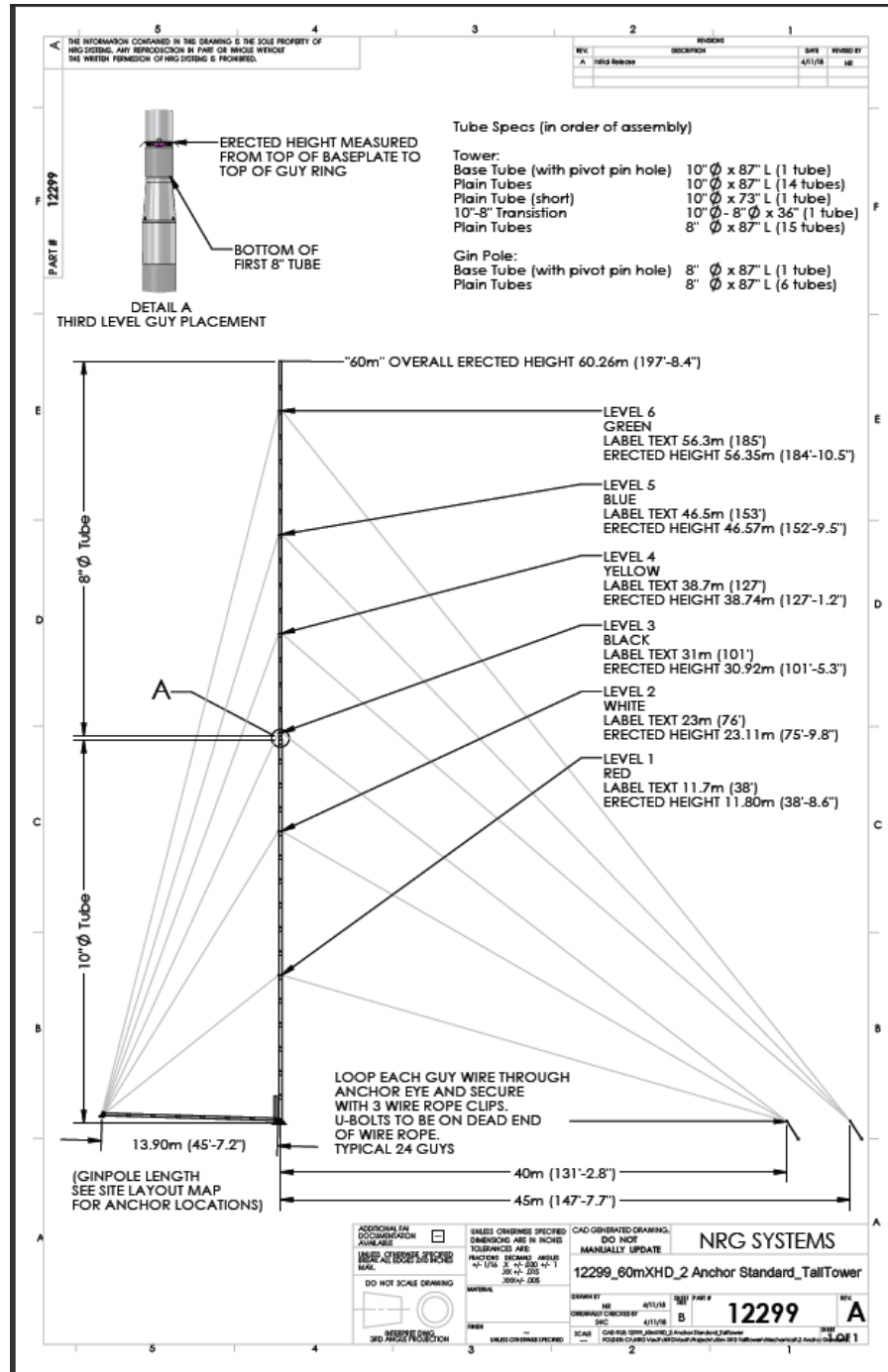

60m XHD: 2 Anchor Standard Footprint

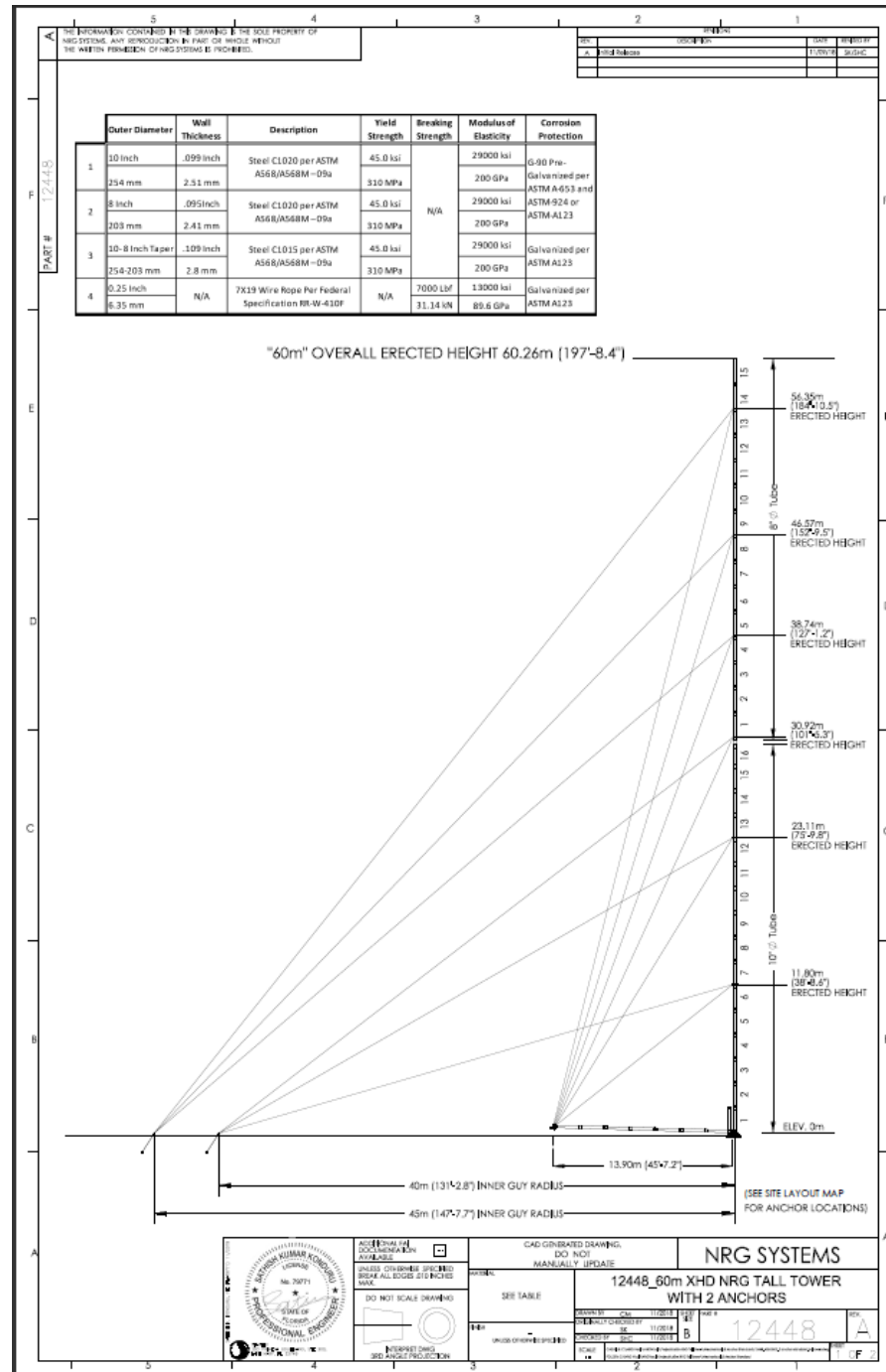

# 60m XHD: 2 Anchor Standard Footprint

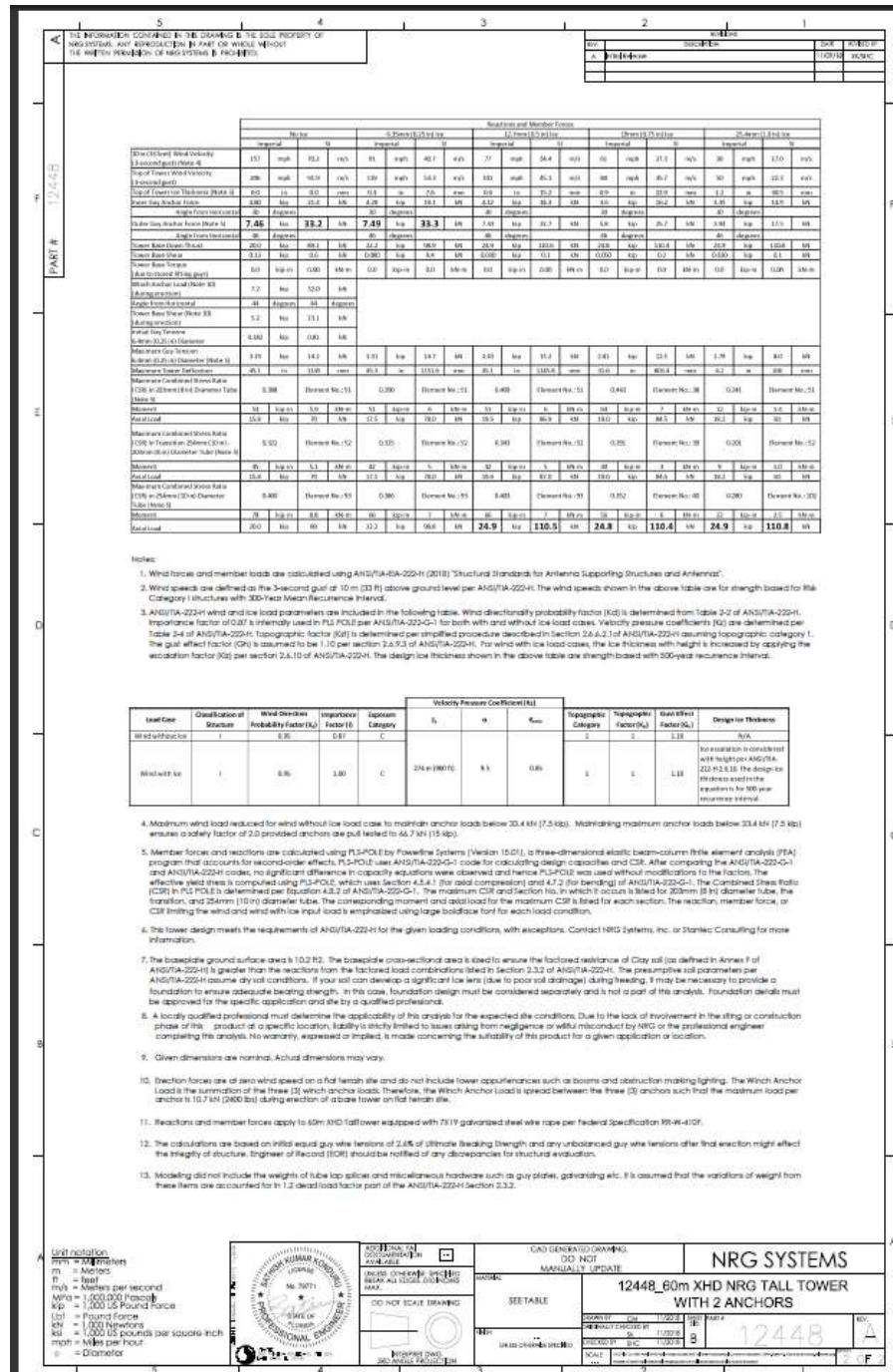

### Site Layout

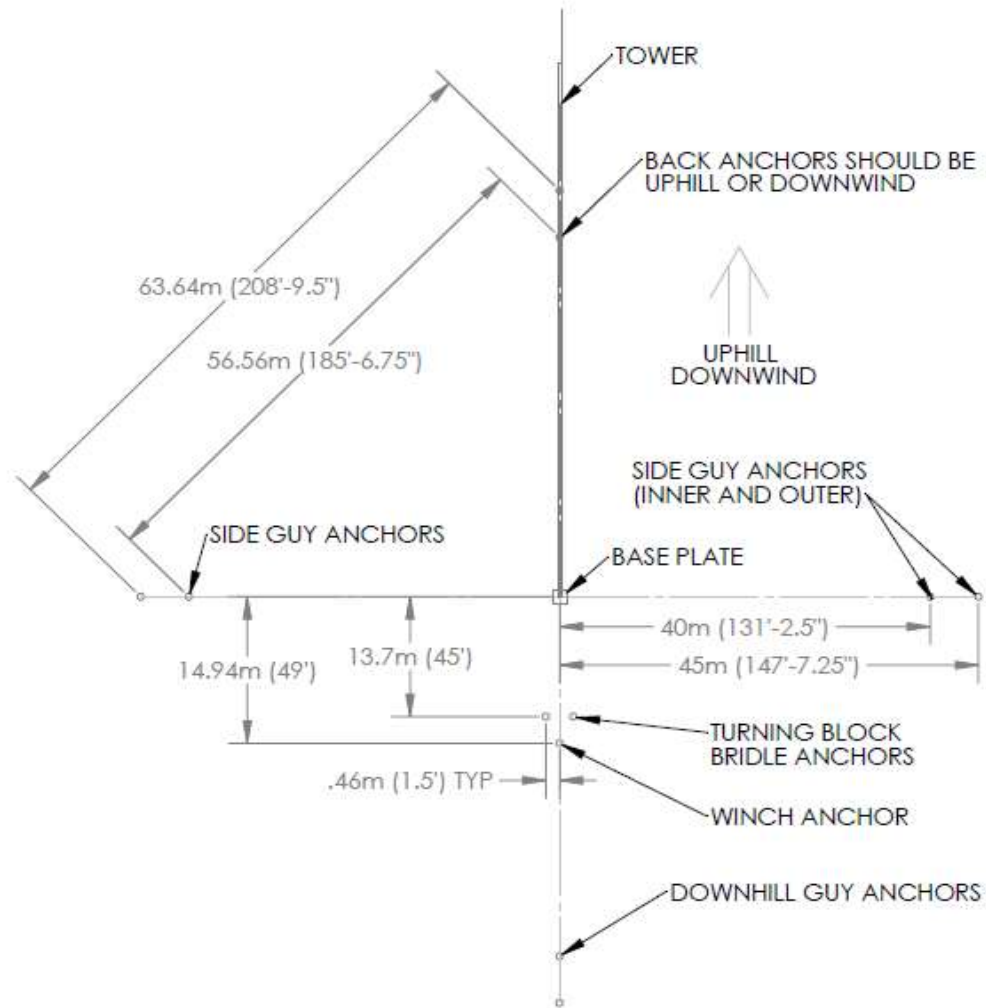

## Appendix D: 60 m XHD with Small Footprint

**Warning:** Small footprint configurations have increased potential for snap-through failure when guy wire tensions have not been well maintained.

The small foot print configurations also significantly increase side guy forces during erecting and lowering. Even experienced installation teams have been surprised by these forces. It is critical to keep the tower straight at all times. This is particularly important when the tower is near the ground where forces are at their greatest and most difficult to control. Use the standard footprint configuration whenever possible.



# Tower Layout

TUBE SPECS (in order of assembly):

Tower:  
 Base Tube (with pivot pin hole) 10"  $\phi$  x 87"L (1 tube)  
 Plain Tubes 10"  $\phi$  x 87"L (14 tubes)  
 Plain Tube (short) 10"  $\phi$  x 73"L (1 tube)  
 10"-8" TRANSITION, 36"L  
 Plain Tubes 8"  $\phi$  x 87"L (15 tubes)

Gin Pole:  
 Base Tube (with pivot pin hole) 8"  $\phi$  x 87"L  
 Plain Tubes 8"  $\phi$  x 87"L

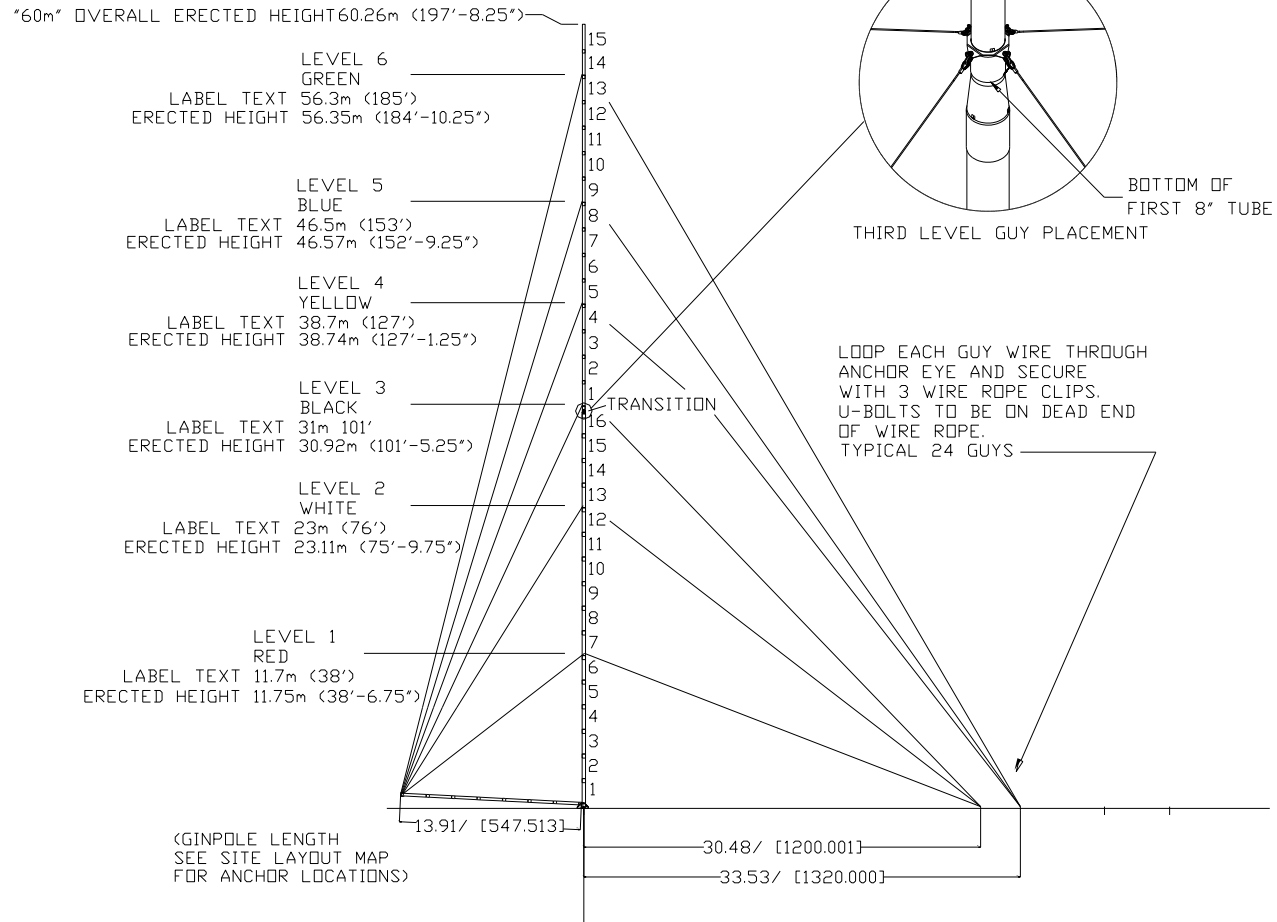

Site Layout

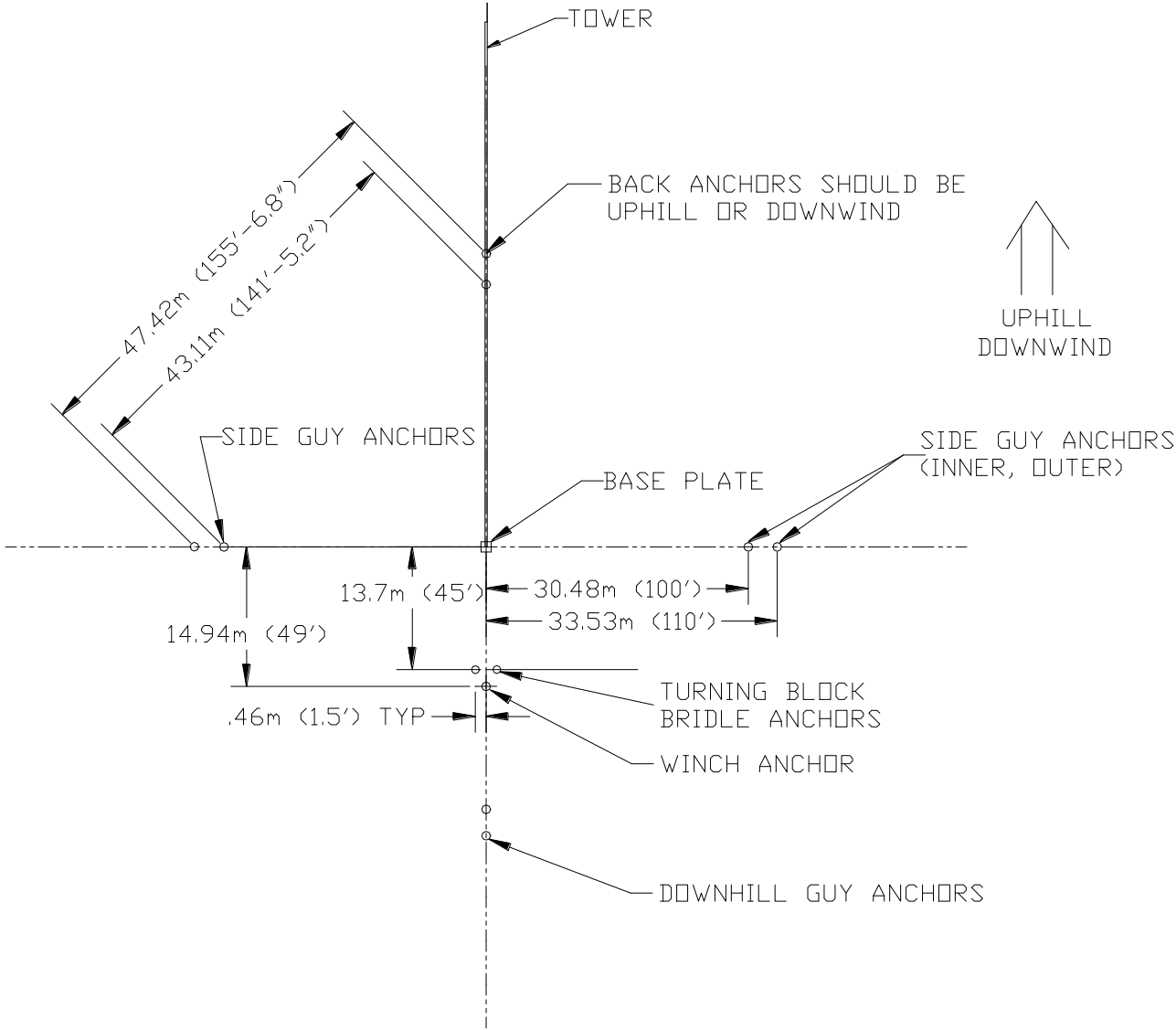

Code Compliance Curve – Imperial Units

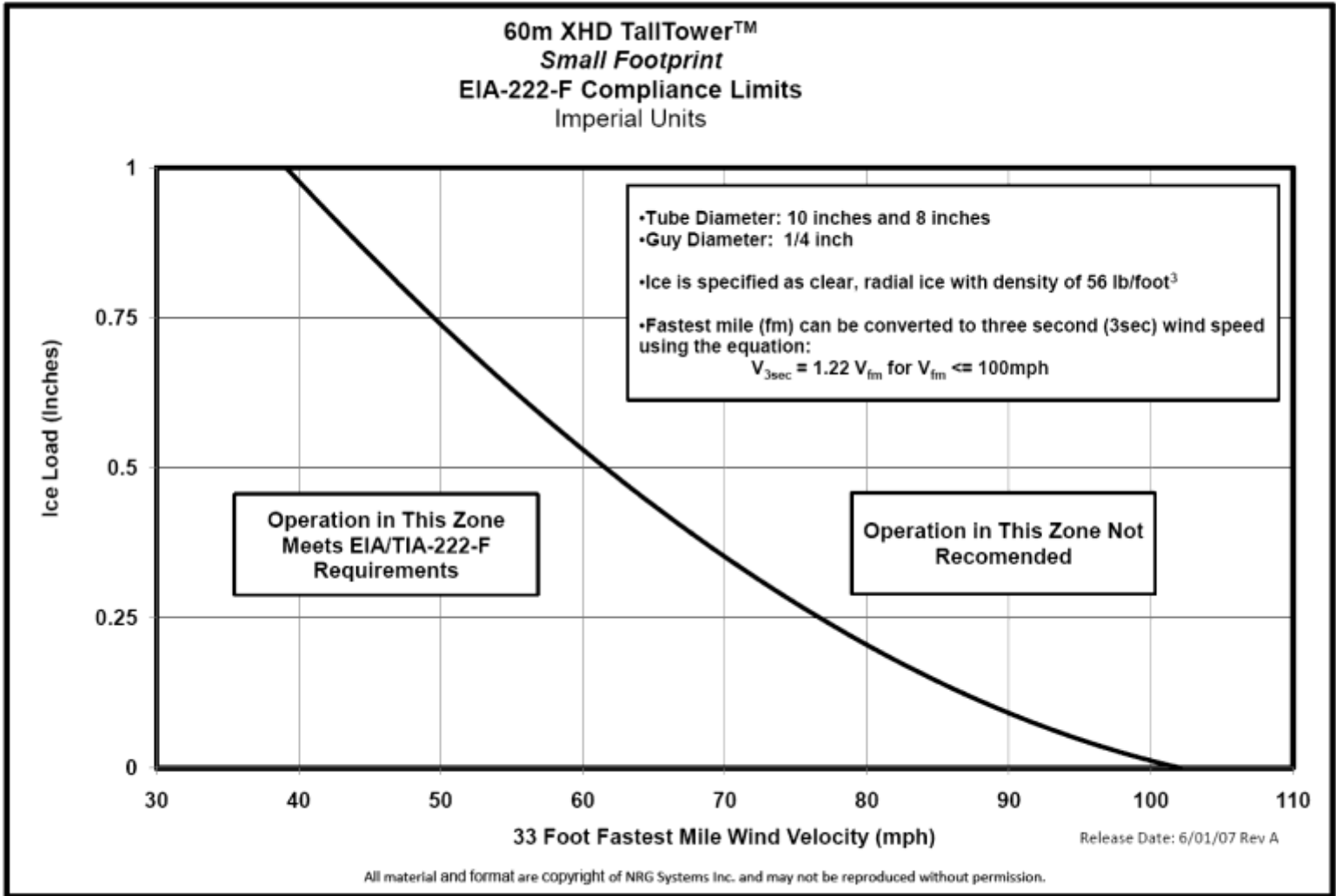

Code Compliance Curve – SI Units

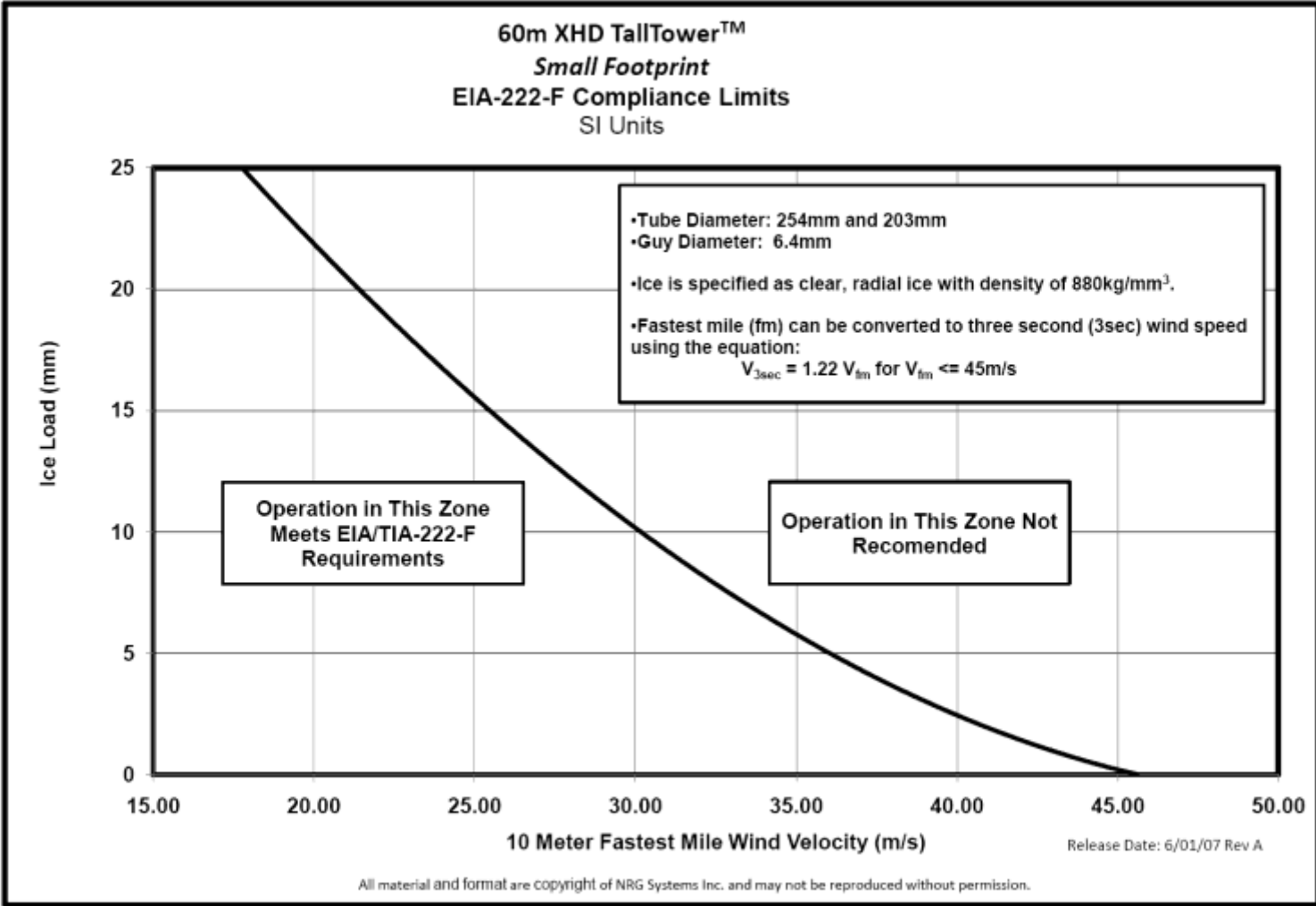

### Anchor Loads – Imperial Units

(The loads shown on the graph apply to each of the anchors)

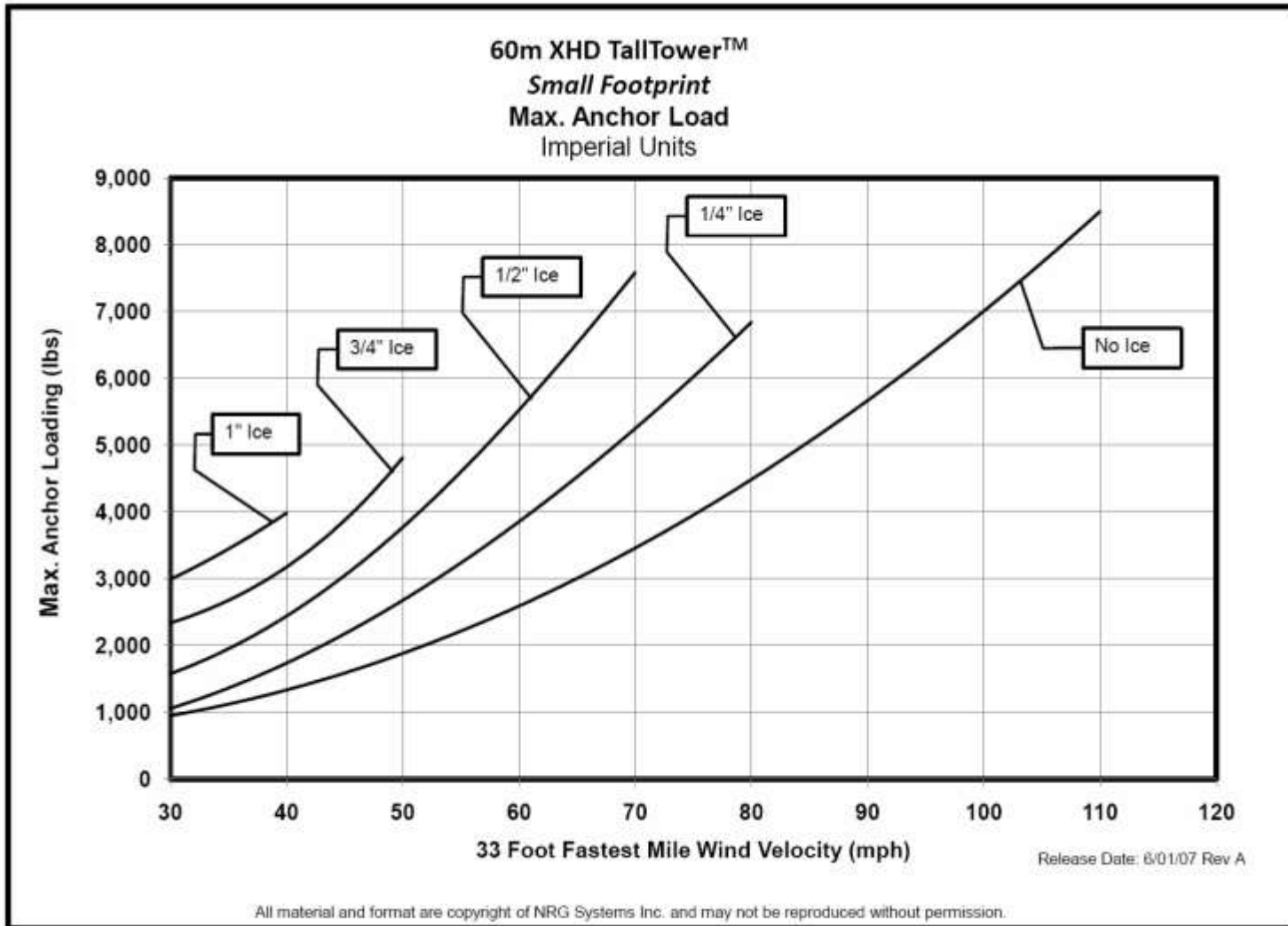



### Anchor Loads – SI Units

(The loads shown on the graph apply to each of the anchors)

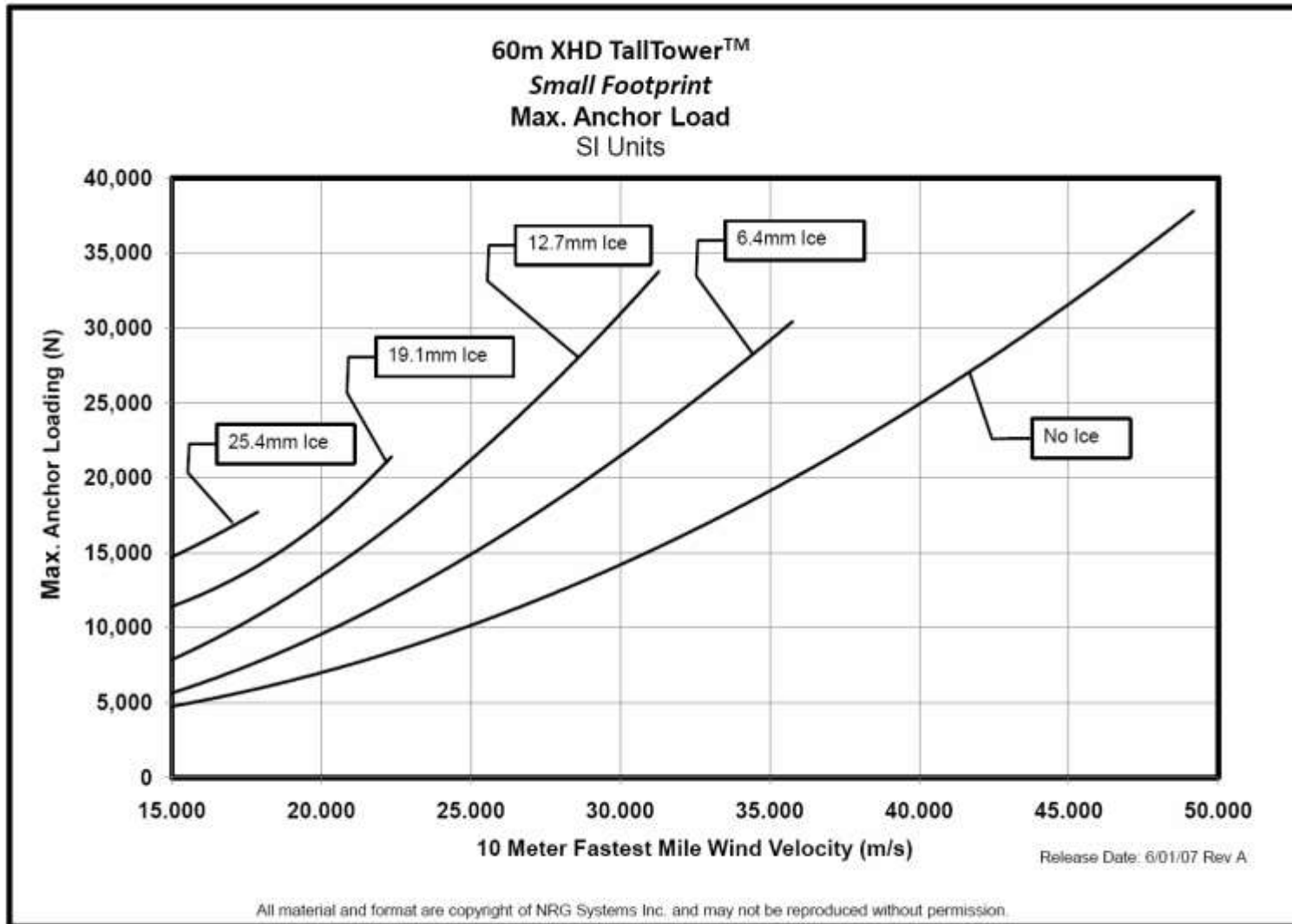

Baseplate Loads – Imperial Units

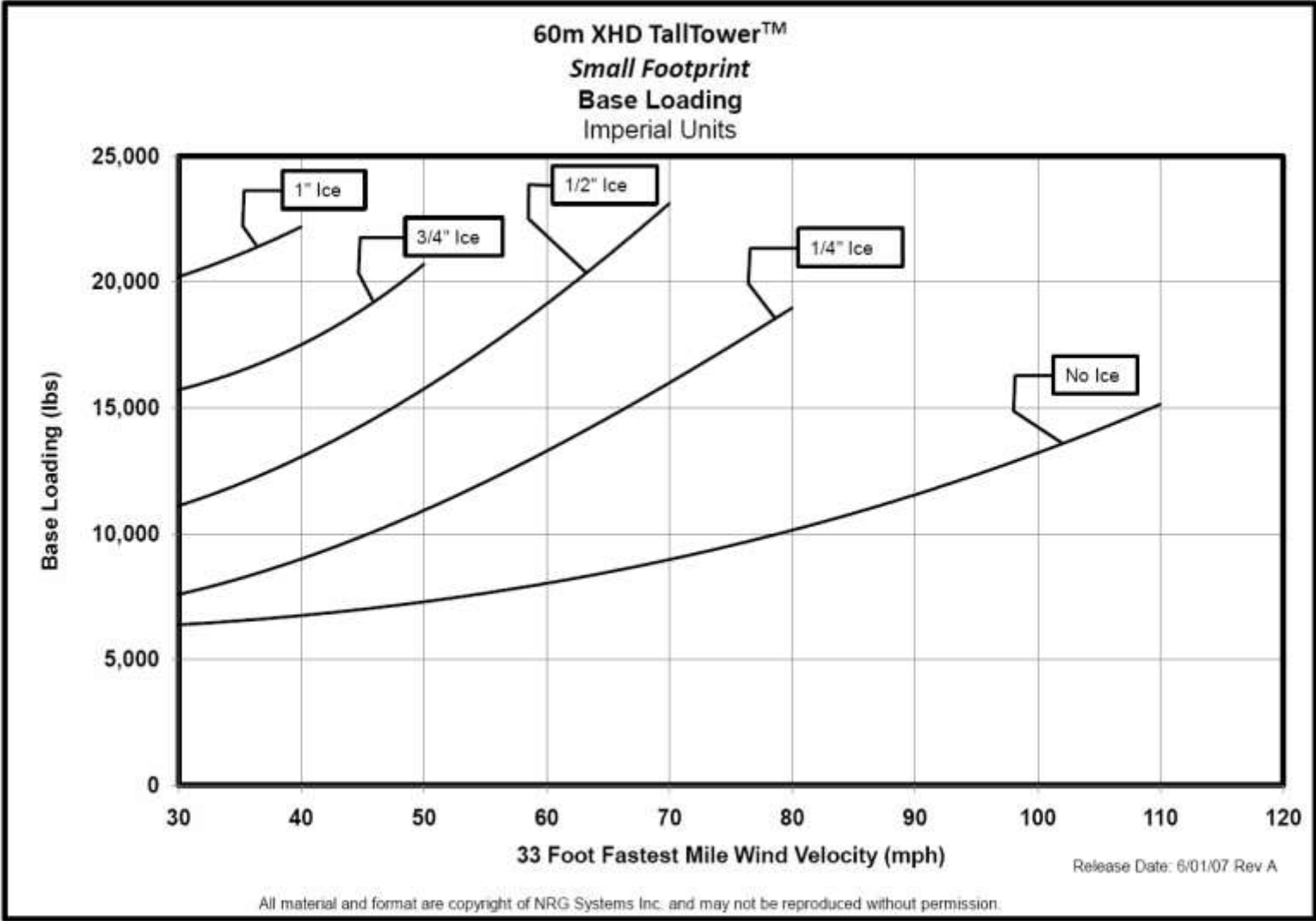

Baseplate Loads – SI Units

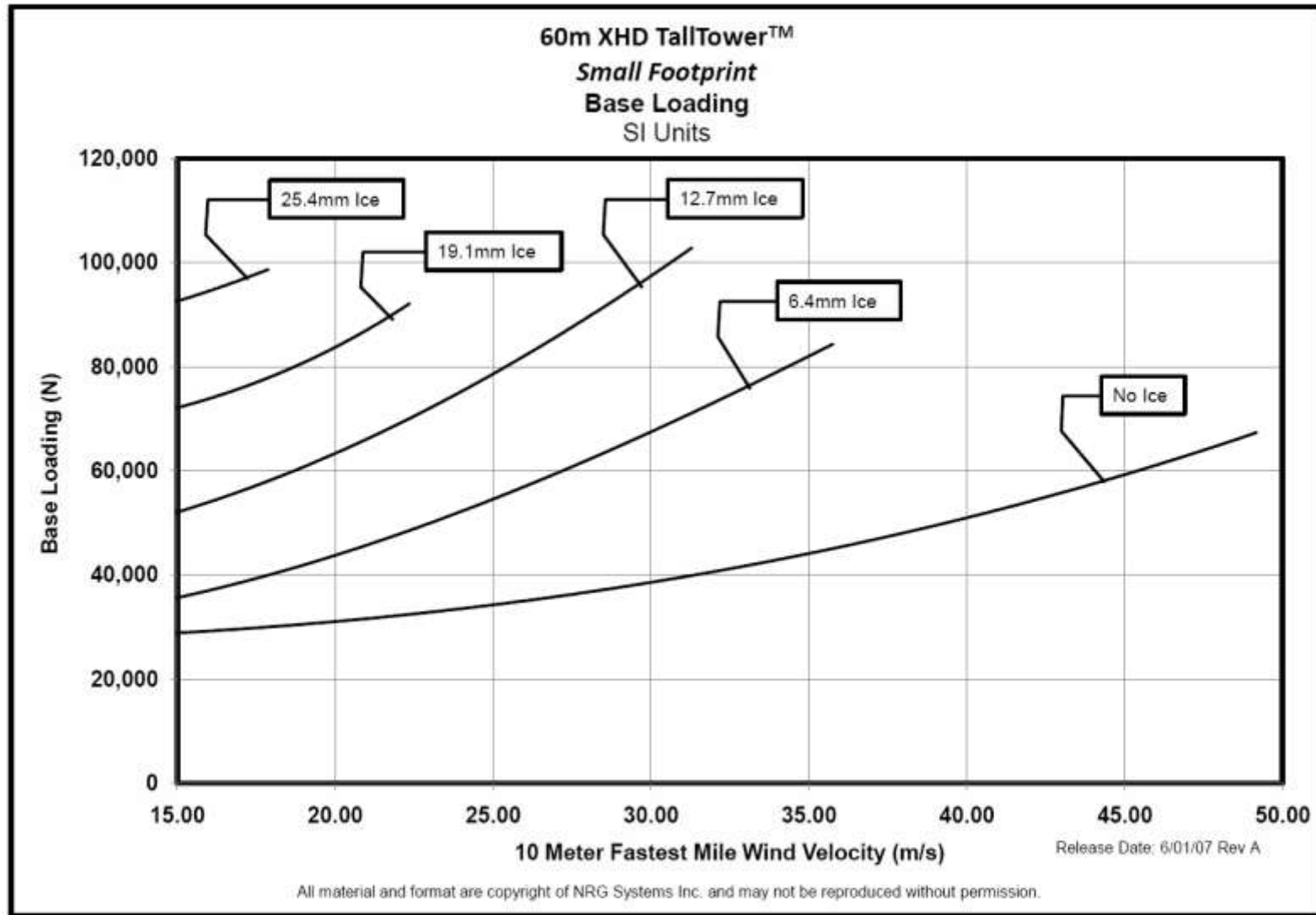

**Tower Erection Forces (tower only)**

EIA-222-F wind velocity	Horizontal base reaction	Winch anchor reaction (b)
0 m/s (0 mph)	23.1 kN (5200 lbs.) (a)	32.0 kN (7200 lbs) @ 44° from Horizontal Load spread between the 3 anchors or 10.7 kN (2400 lbs) per anchor

**Tower Erection Forces (with typical NOW System – 2 booms at 40 m, 3 booms at 50 m, 3 booms at 58 m, cables)**

EIA-222-F wind velocity	Horizontal base reaction	Winch anchor reaction (b)
0 m/s (0 mph)	25.8 kN (5800 lbs.) (a)	35.6 kN (8000 lbs) @ 44° from Horizontal Load spread between the 3 anchors or 11.9 kN (2667 lbs) per anchor

Notes:

- a) The maximum horizontal reaction occurs when the tower is just off the ground.
- b) Maximum force on the winch anchor during tower erection (occurs when tower is just above the ground).
- c) These values assume no safety factor.

## Baseplate Geometry

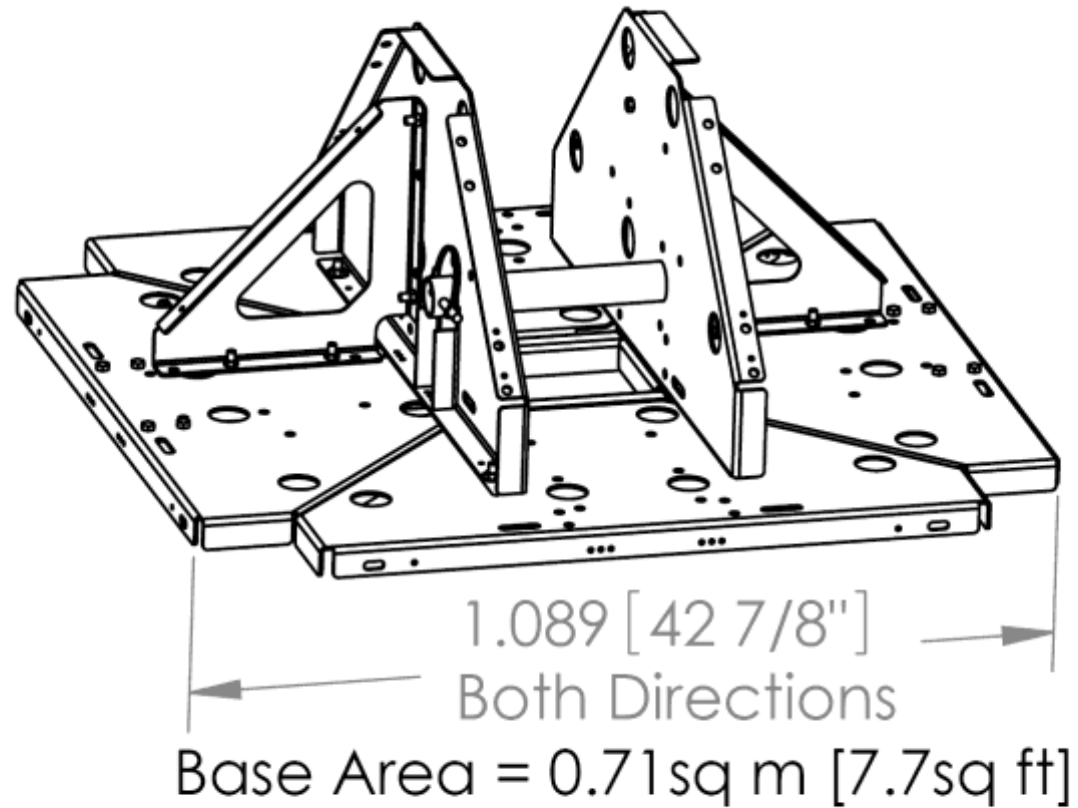



60m XHD with Small Footprint

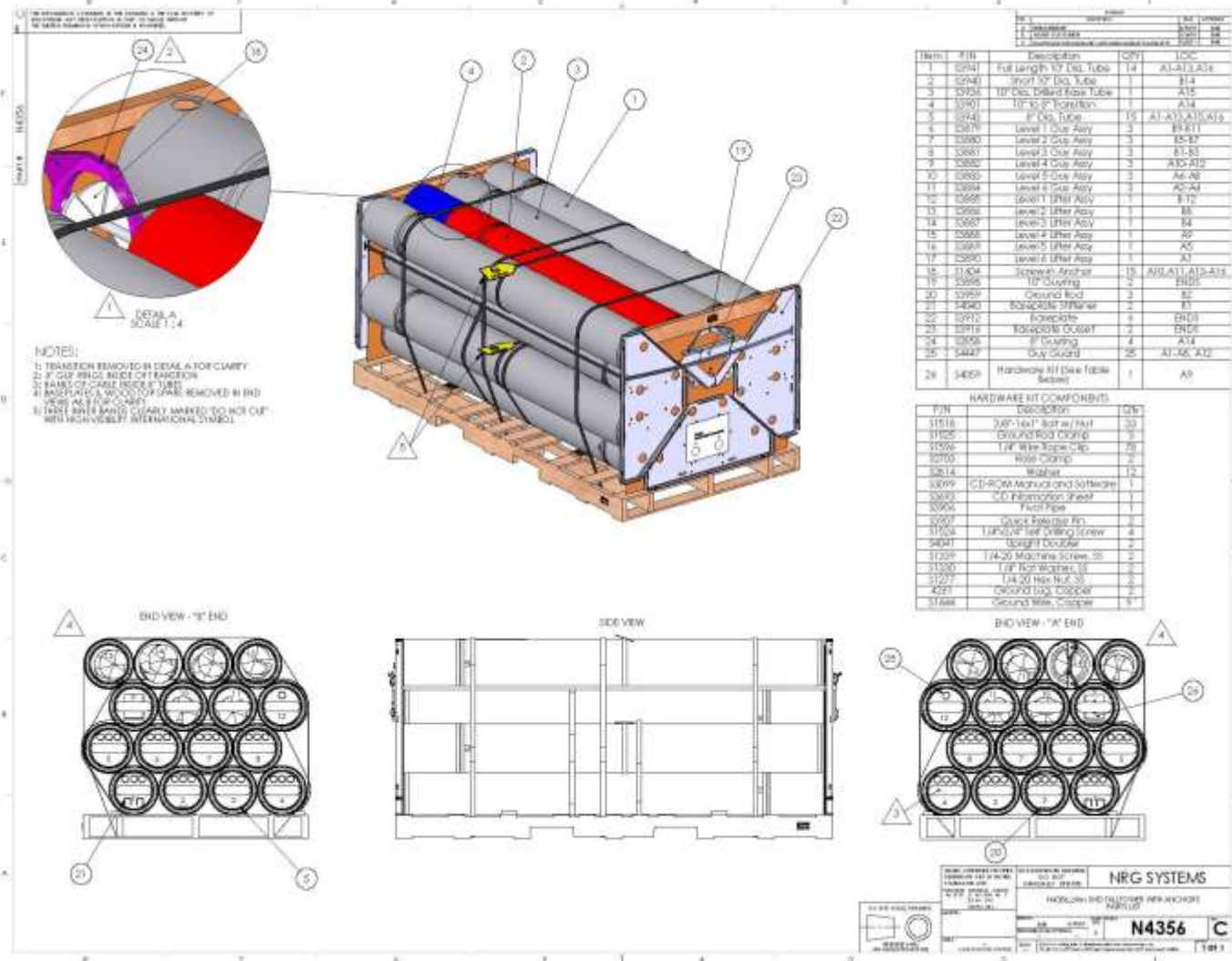

## Appendix E: 60m XHD with Single Anchor

### Tower Layout

# 60m XHD with Single Anchor

TUBE SPECS (in order of assembly):

Tower:  
 Base Tube (with pivot pin hole) 10" Ø x 87'L (1 tube)  
 Plain Tubes 10" Ø x 87'L (14 tubes)  
 Plain Tube (short) 10" Ø x 73'L (1 tube)  
 10"-8" TRANSITION, 36"L  
 Plain Tubes 8" Ø x 87'L (15 tubes)

Gin Pole:  
 Base Tube (with pivot pin hole) 8" Ø x 87'L  
 Plain Tubes 8" Ø x 87'L

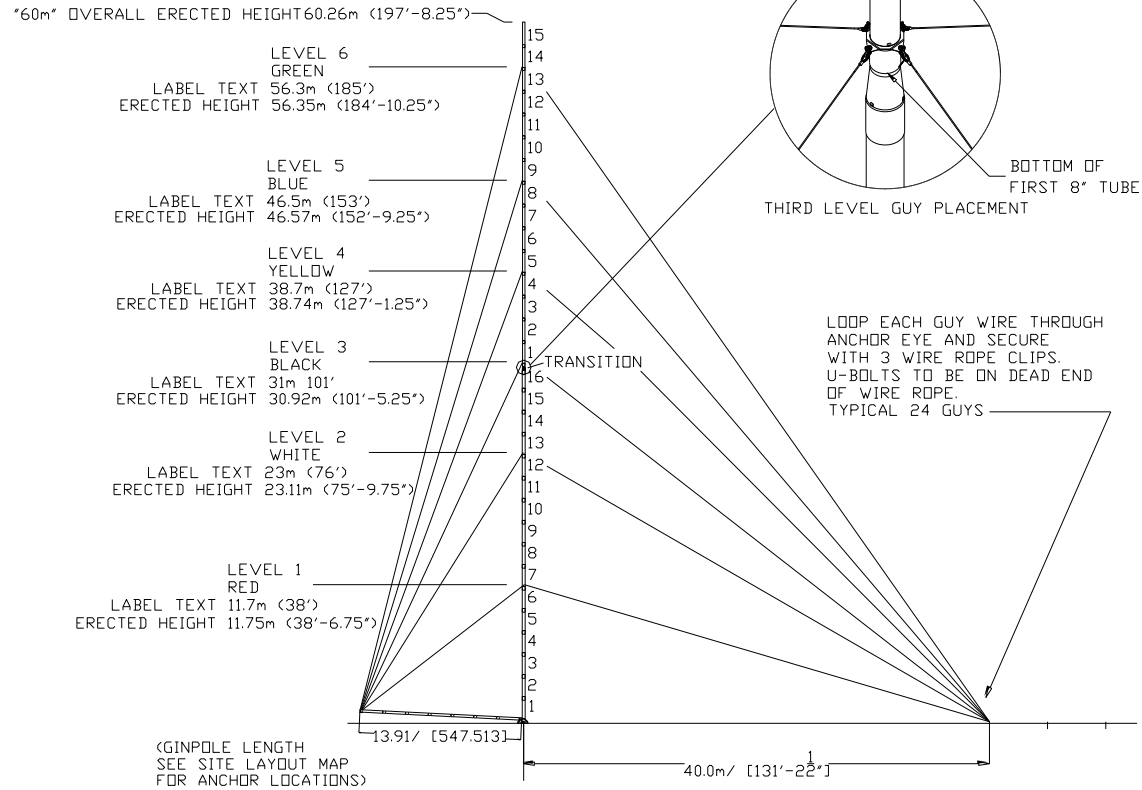

60m XHD with Single Anchor

Site Layout

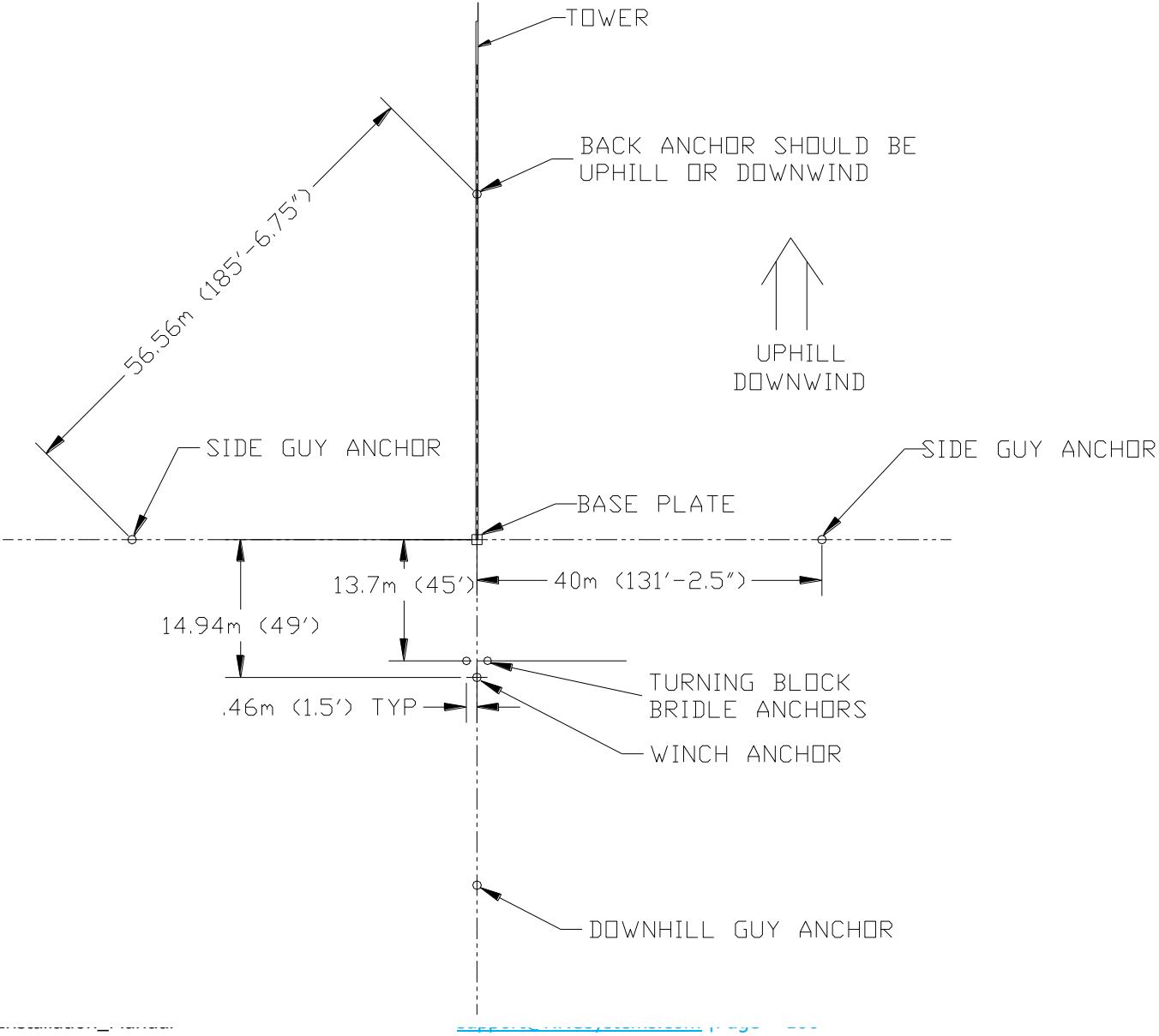

60m XHD with  
Single Anchor

Code Compliance Curve – Imperial Units

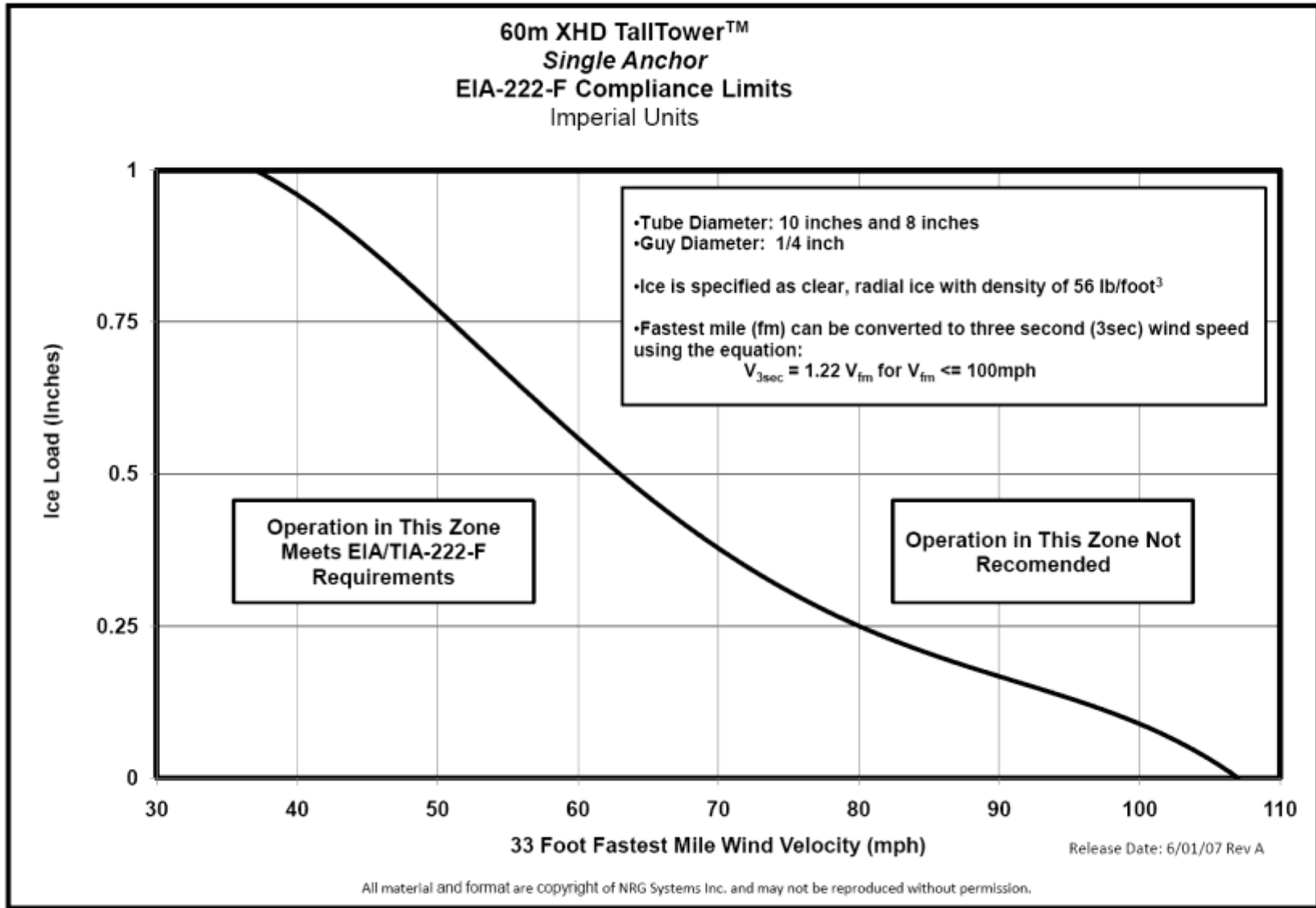

60m XHD with  
Single Anchor

Code Compliance Curve – SI Units

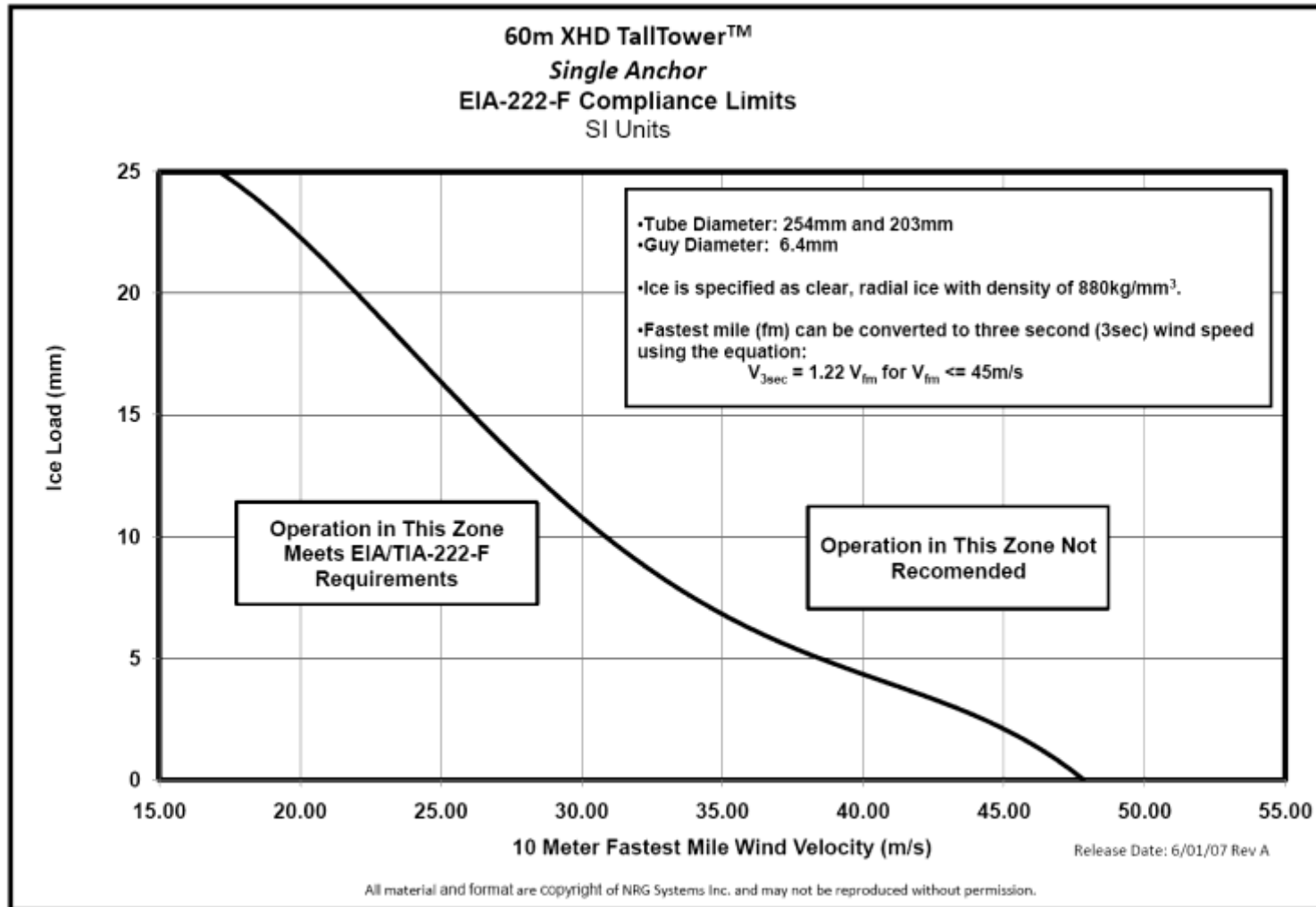



60m XHD with  
Single Anchor

Anchor Loads – Imperial Units (The loads shown on the graph apply to each of the anchors)

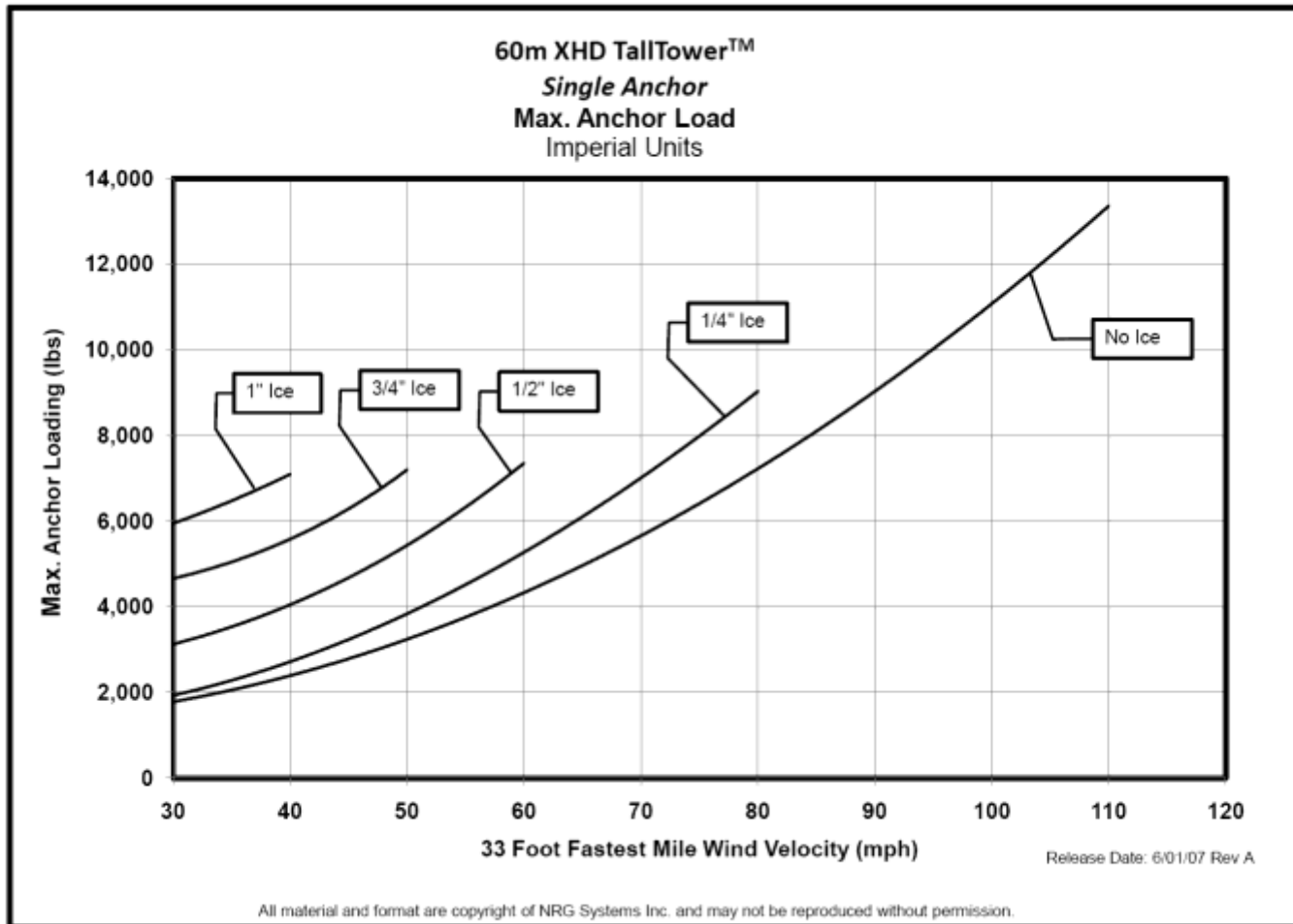

60m XHD with  
Single Anchor

**Anchor Loads – SI Units** (The loads shown on the graph apply to each of the anchors)

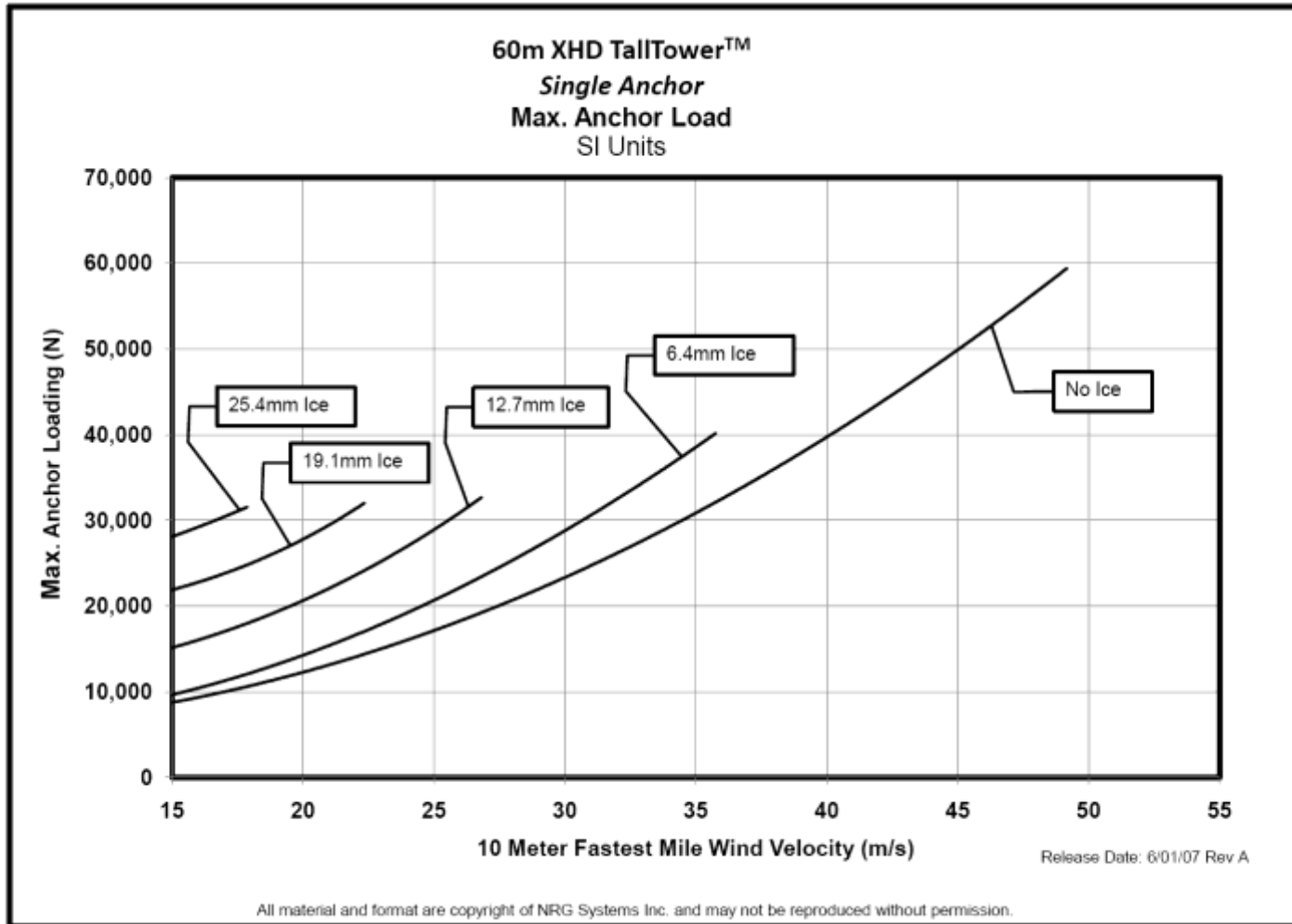

60m XHD with  
Single Anchor

Baseplate Load – Imperial Units

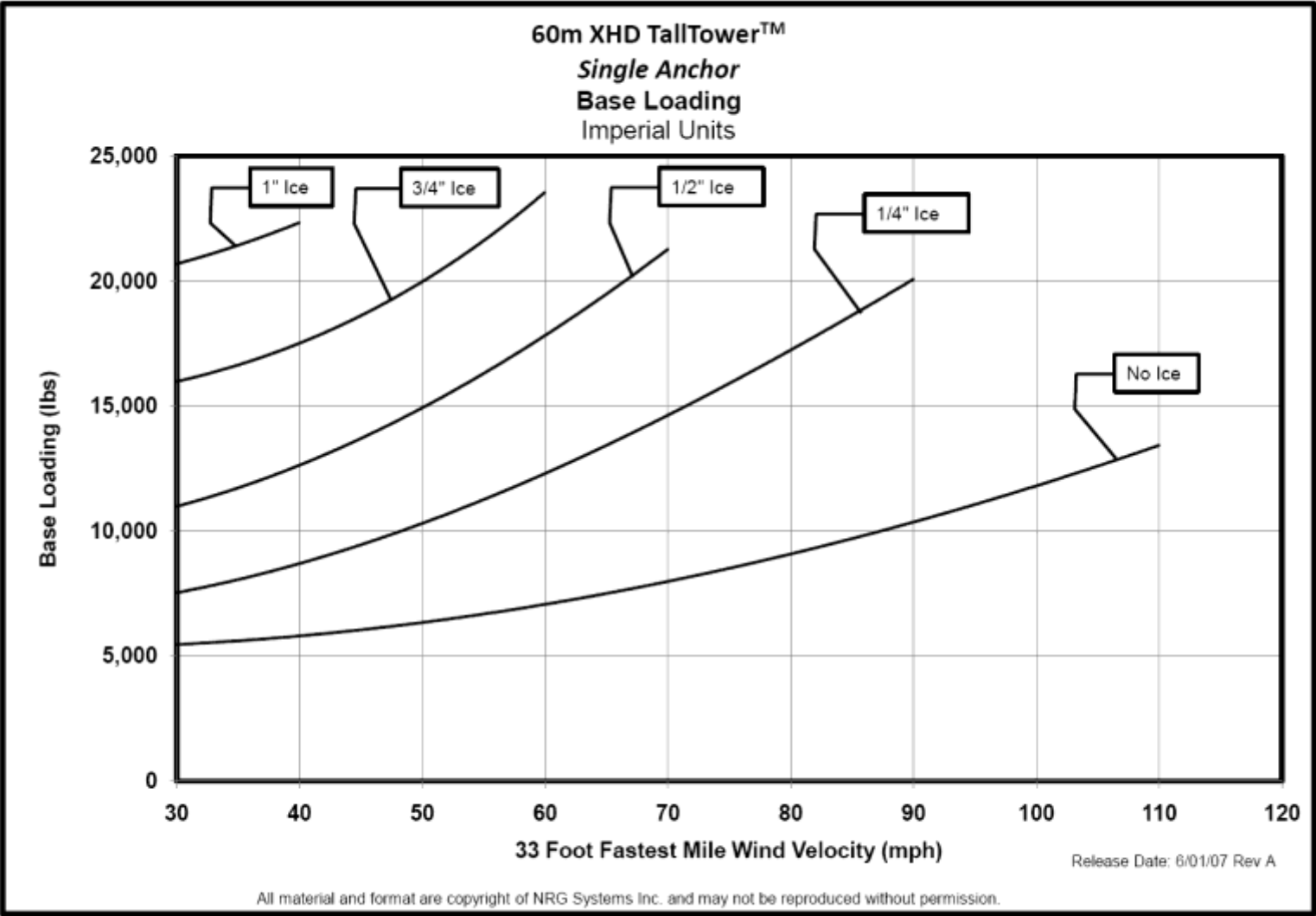

60m XHD with  
Single Anchor

Baseplate Load – SI Units

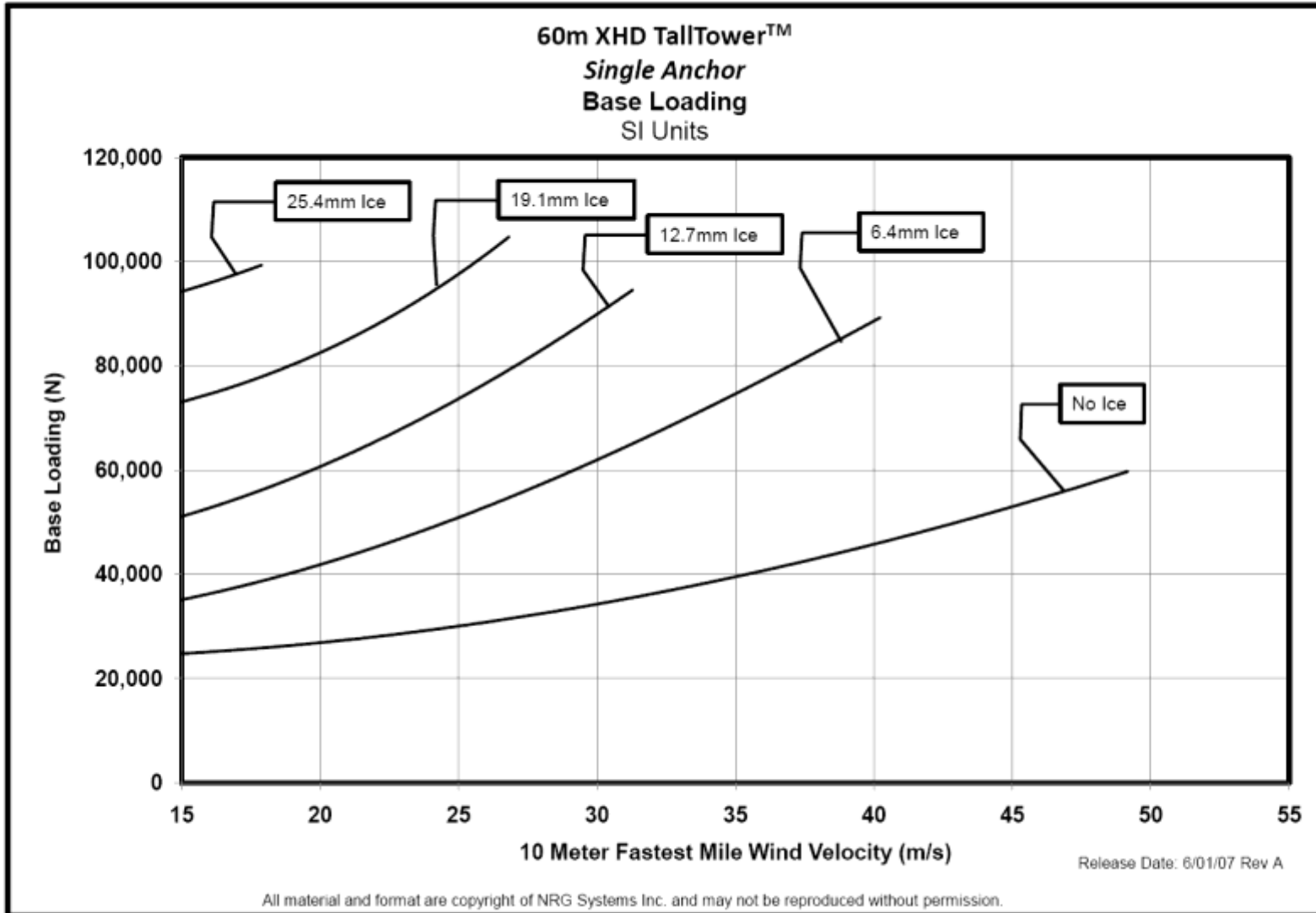

**Tower Erection Forces (tower only)**

EIA-222-F wind velocity	Horizontal base reaction	Winch anchor reaction (b)
0 m/s (0 mph)	23.1 kN (5200 lbs.) (a)	32.0 kN (7200 lbs) @ 44° from Horizontal Load spread between the 3 anchors or 10.7 kN (2400 lbs) per anchor

**Tower Erection Forces (with typical NOW System – 2 booms at 40 m, 3 booms at 50 m, 3 booms at 58 m, cables)**

EIA-222-F wind velocity	Horizontal base reaction	Winch anchor reaction (b)
0 m/s (0 mph)	25.8 kN (5800 lbs.) (a)	35.6 kN (8000 lbs) @ 44° from Horizontal Load spread between the 3 anchors or 11.9 kN (2667 lbs) per anchor

Notes:

- a) The maximum horizontal reaction occurs when the tower is just off the ground.
- b) Maximum force on the winch anchor during tower erection (occurs when tower is just above the ground).
- c) These values assume no safety factor.

## Baseplate Geometry

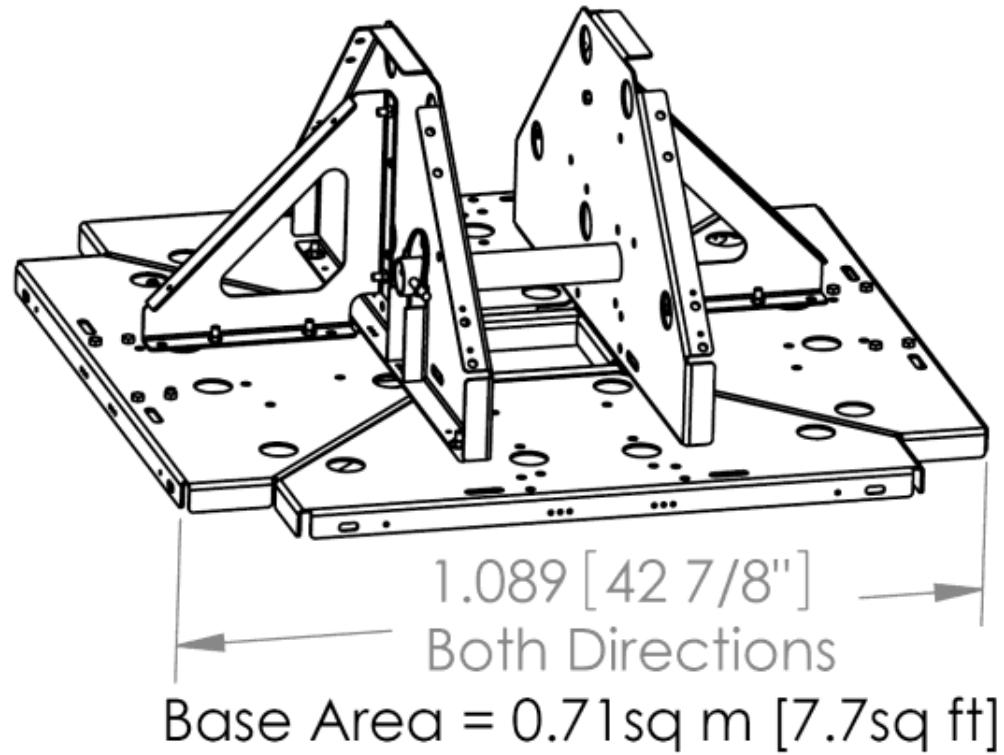



# 60m XHD with Single Anchor

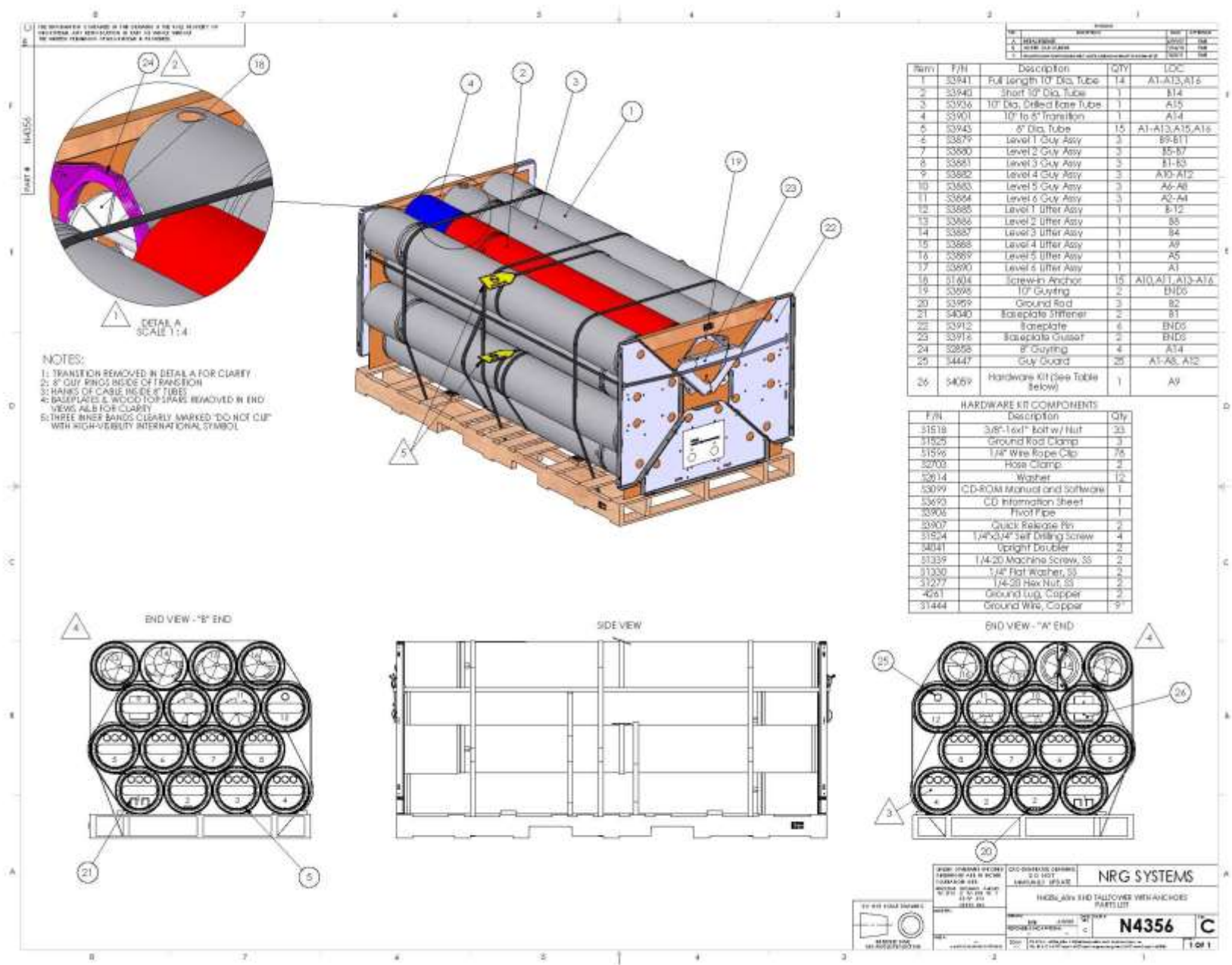

## Appendix F: 50m XHD with Standard Footprint

### Tower Layout

# 50m XHD with Standard Footprint

TUBE SPECS (in order of assembly):

- Tower:**  
 Base Tube (with pivot pin hole) 10"  $\phi$  x 87"L (1 tube)  
 Plain Tubes 10"  $\phi$  x 87"L (14 tubes)  
 Plain Tube (short) 10"  $\phi$  x 73"L (1 tube)  
 10'-8" TRANSITION, 36"L Plain Tubes 8"  $\phi$  x 87"L (10 tubes)
- Gin Pole:**  
 Base Tube (with pivot pin hole) 8"  $\phi$  x 87"L  
 Plain Tubes 8"  $\phi$  x 87"L

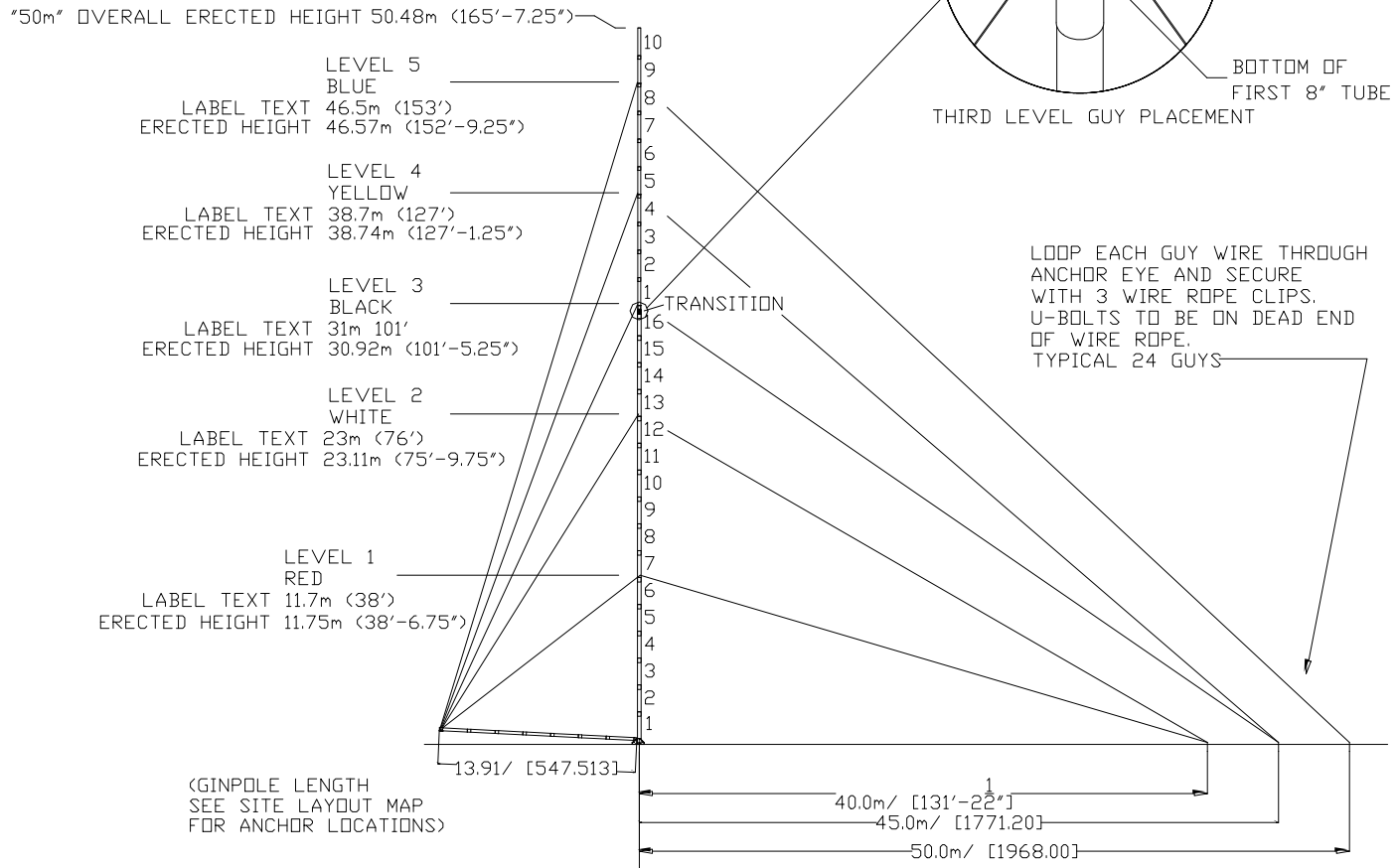
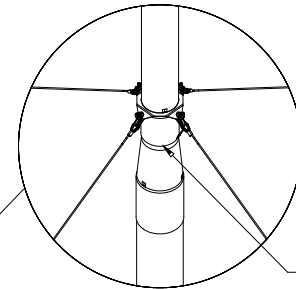

50m XHD with  
Standard Footprint

Site Layout

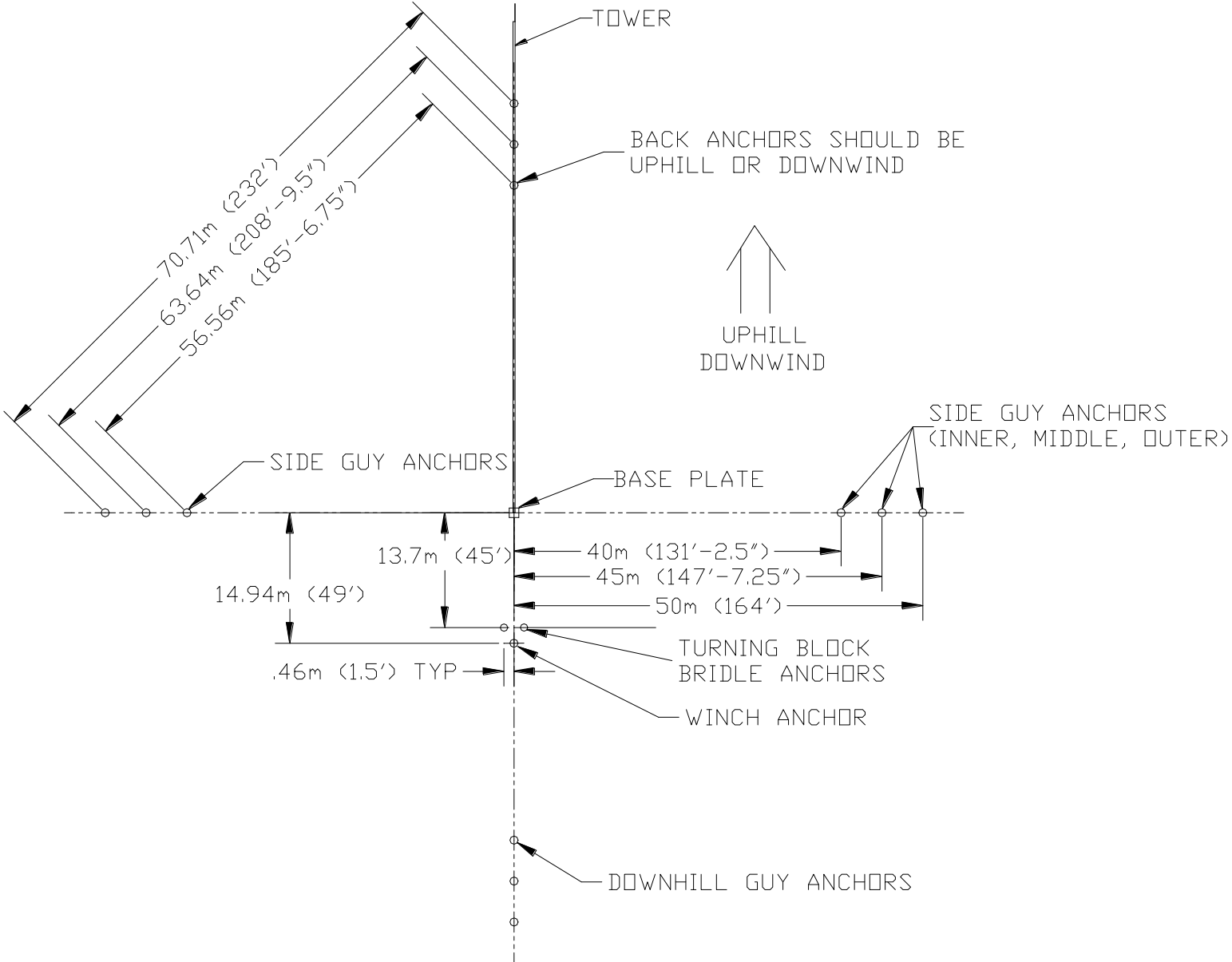

Code Compliance Curve – Imperial Units

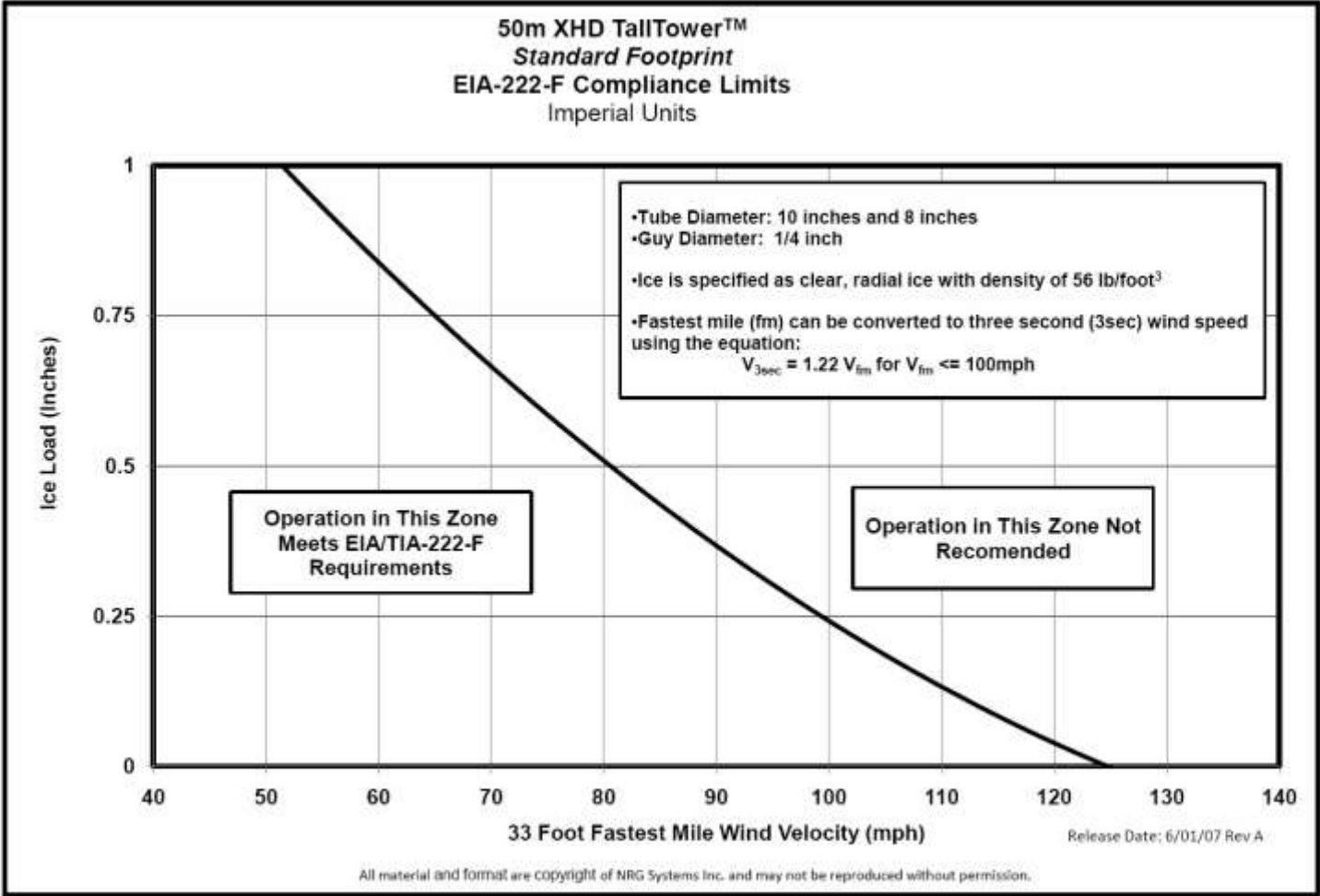

### Code Compliance Curve - SI Units

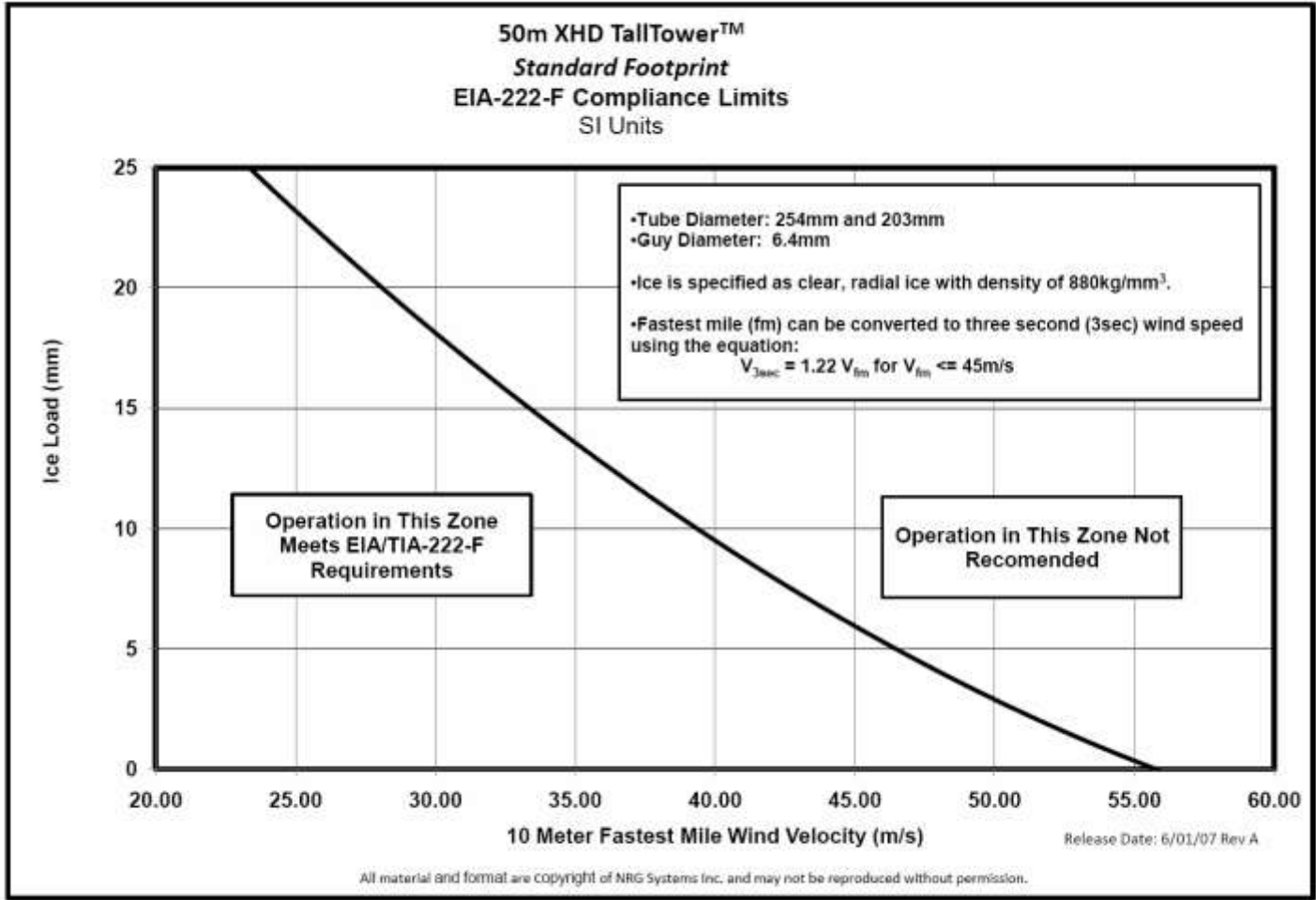



Anchor Loads – Imperial Units (The loads shown on the graph apply to each of the anchors)

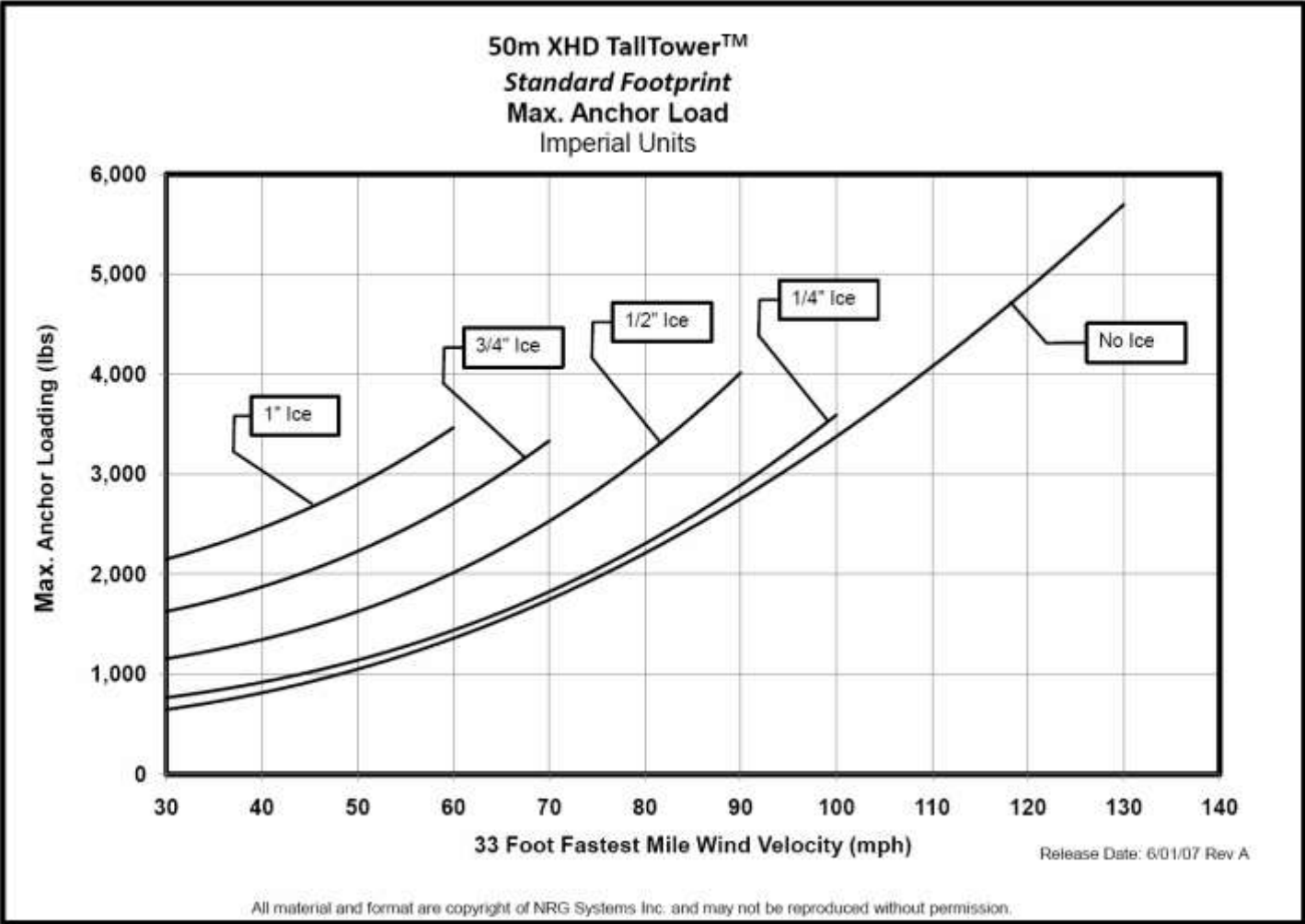

Anchor Loads – SI Units (The loads shown on the graph apply to each of the anchors)

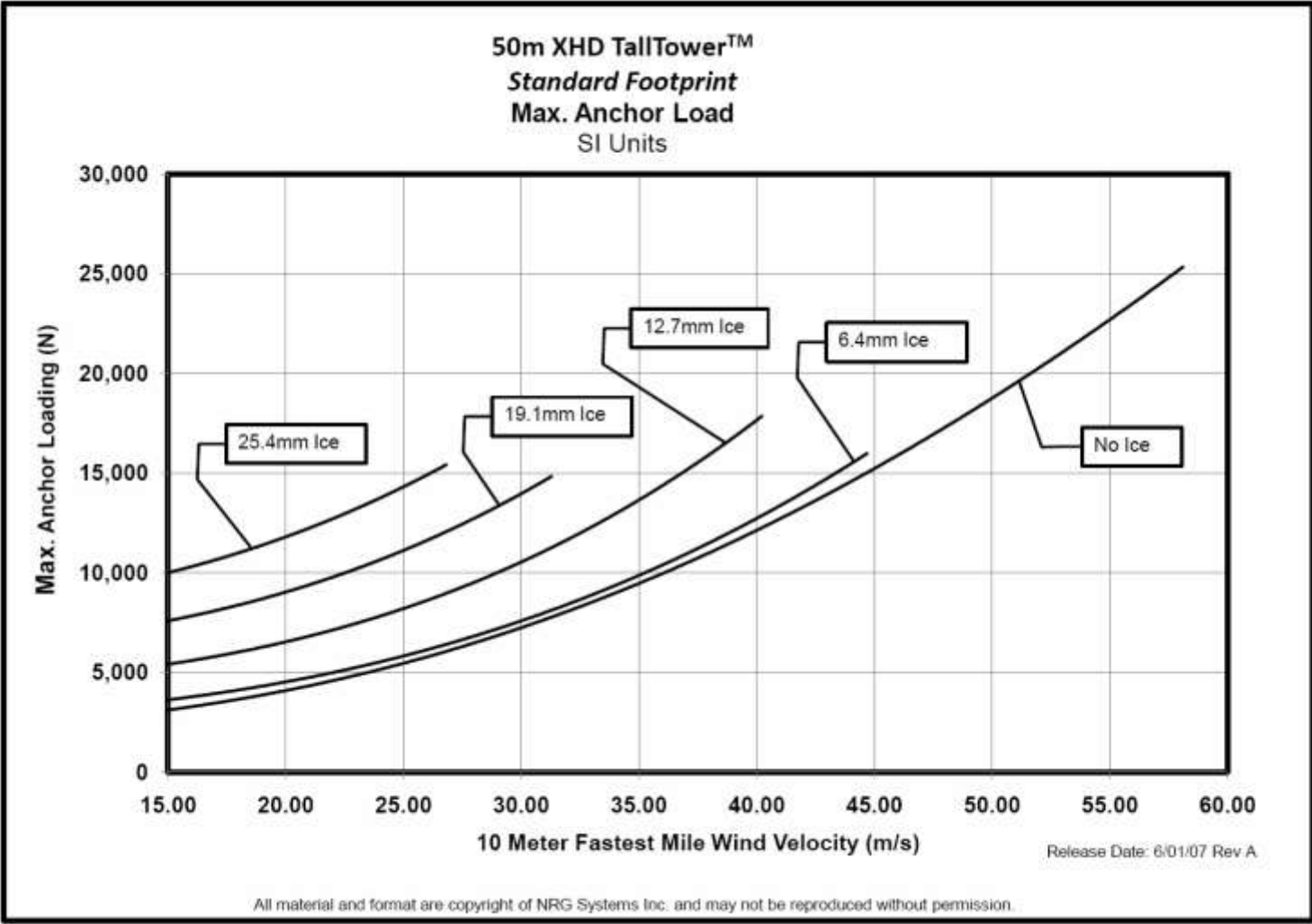

### Baseplate Loads – Imperial Units

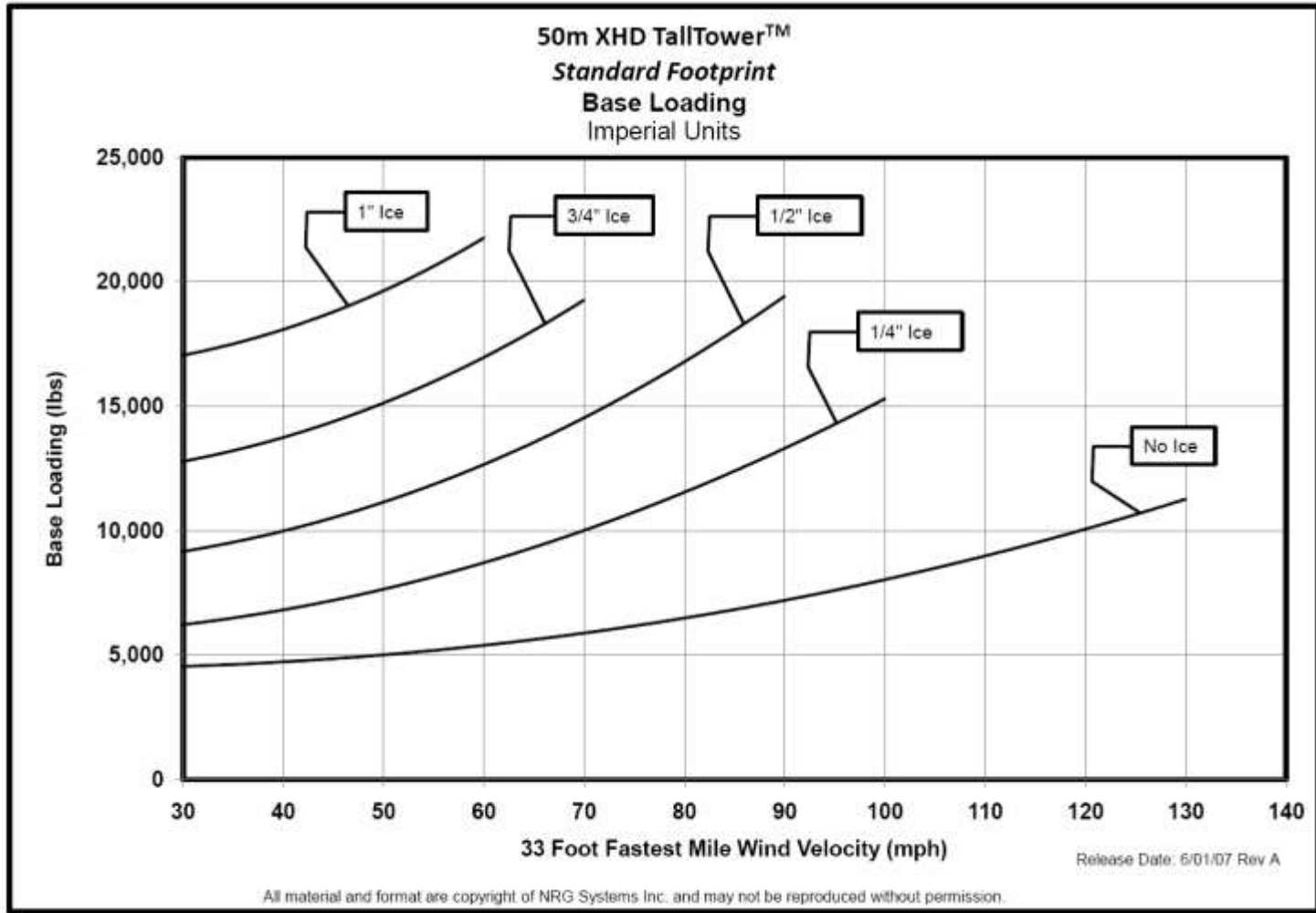

### Baseplate Loads – SI Units

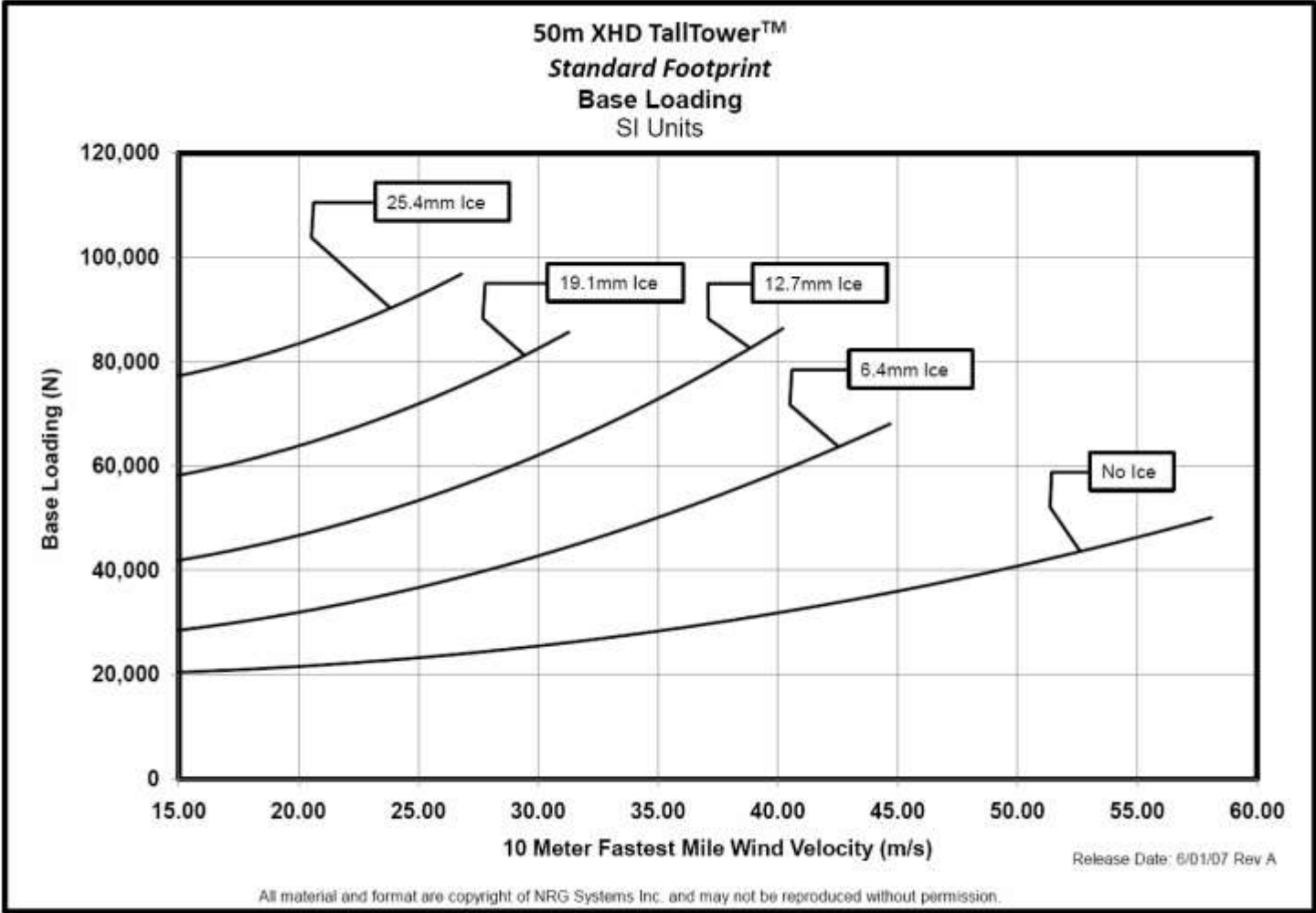

### Tower Erection Forces (tower only)

EIA-222-F wind velocity	Horizontal base reaction	Winch anchor reaction (b)
0 m/s (0 mph)	16.9 kN (3800 lbs.) (a)	23.1 kN (5200 lbs) @ 44° from Horizontal Load spread between the 3 anchors or 7.7kN (1733 lbs) per anchor

### Tower Erection Forces (with typical NOW System – 2 booms at 30 m, 3 booms at 40 m, 3 booms at 50 m, cables)

EIA-222-F wind velocity	Horizontal base reaction	Winch anchor reaction (b)
0 m/s (0 mph)	19.1 kN (4300 lbs.) (a)	26.2 kN (5900 lbs) @ 44° from Horizontal Load spread between the 3 anchors or 8.7 kN (1967 lbs) per anchor

Notes:

- a) The maximum horizontal reaction occurs when the tower is just off the ground.
- b) Maximum force on the winch anchor during tower erection (occurs when tower is just above the ground).
- c) These values assume no safety factor.

Baseplate Geometry

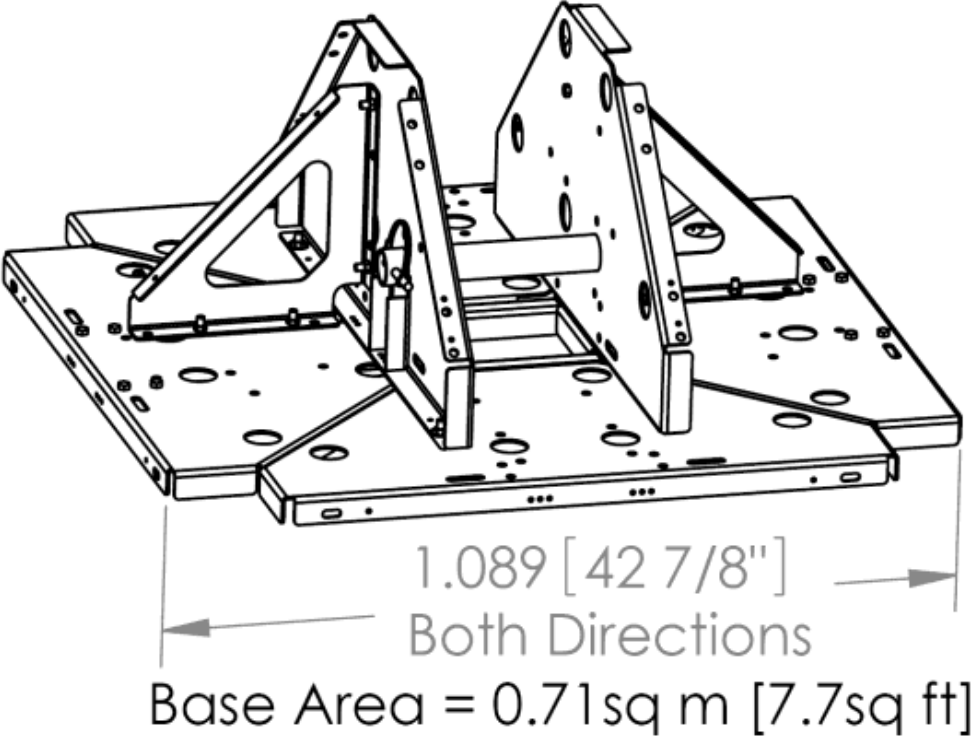



# 50m XHD with Standard Footprint

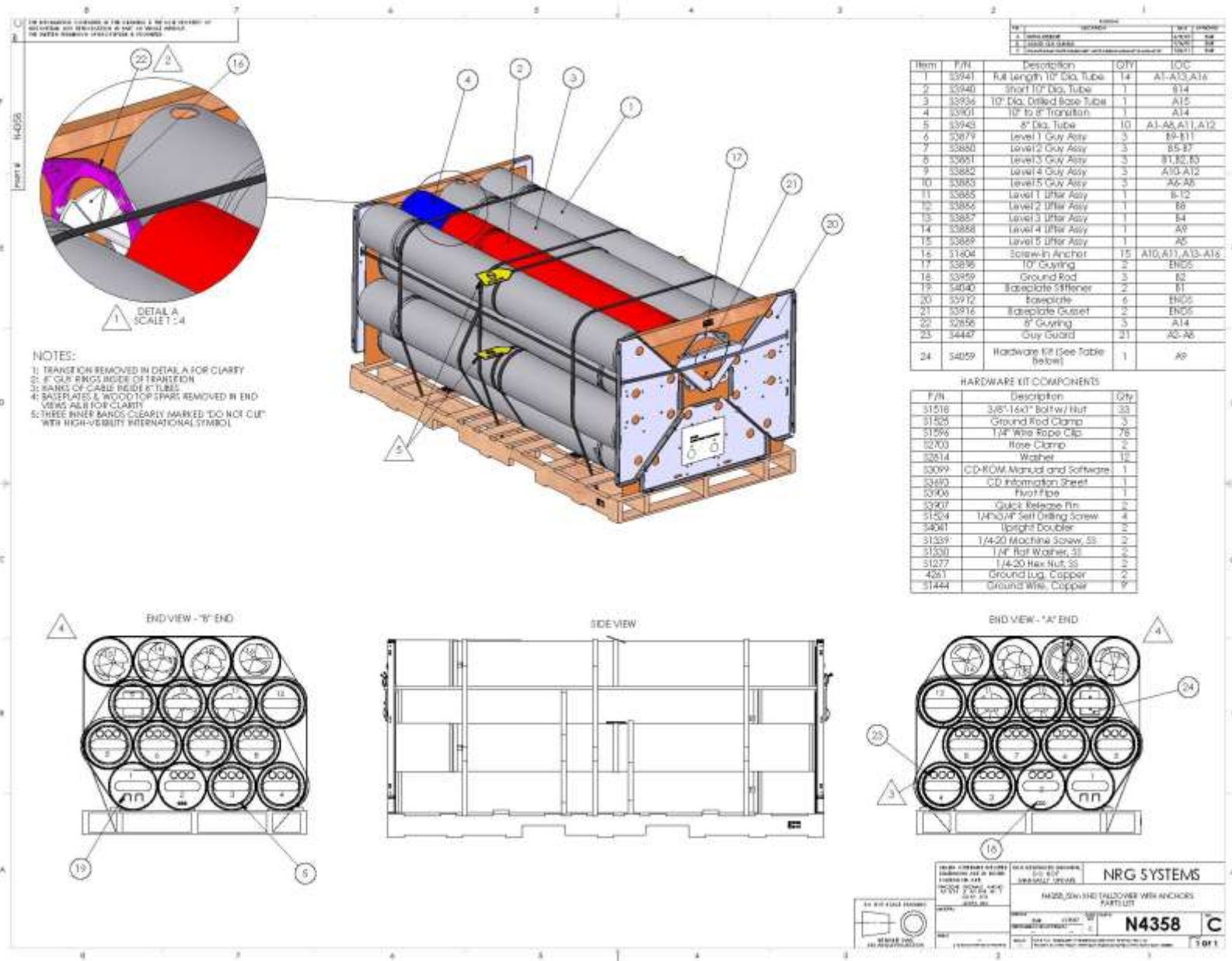

## Appendix G: 50m XHD with Small Footprint

**Warning:** Small footprint configurations have increased potential for snap-through failure when guy wire tensions have not been well maintained.

The small foot print configurations also significantly increase side guy forces during erecting and lowering. Even experienced installation teams have been surprised by these forces. It is critical to keep the tower straight at all times. This is particularly important when the tower is near the ground where forces are at their greatest and most difficult to control. Use the standard footprint configuration whenever possible.

# 50m XHD with Small Footprint

TUBE SPECS (in order of assembly):

Tower:  
 Base Tube (with pivot pin hole) 10"  $\phi$  x 87"L (1 tube)  
 Plain Tubes 10"  $\phi$  x 87"L (14 tubes)  
 Plain Tube (short) 10"  $\phi$  x 73"L (1 tube)  
 10"-8" TRANSITION, 36"L  
 Plain Tubes 8"  $\phi$  x 87"L (10 tubes)

Gin Pole:  
 Base Tube (with pivot pin hole) 8"  $\phi$  x 87"L  
 Plain Tubes 8"  $\phi$  x 87"L

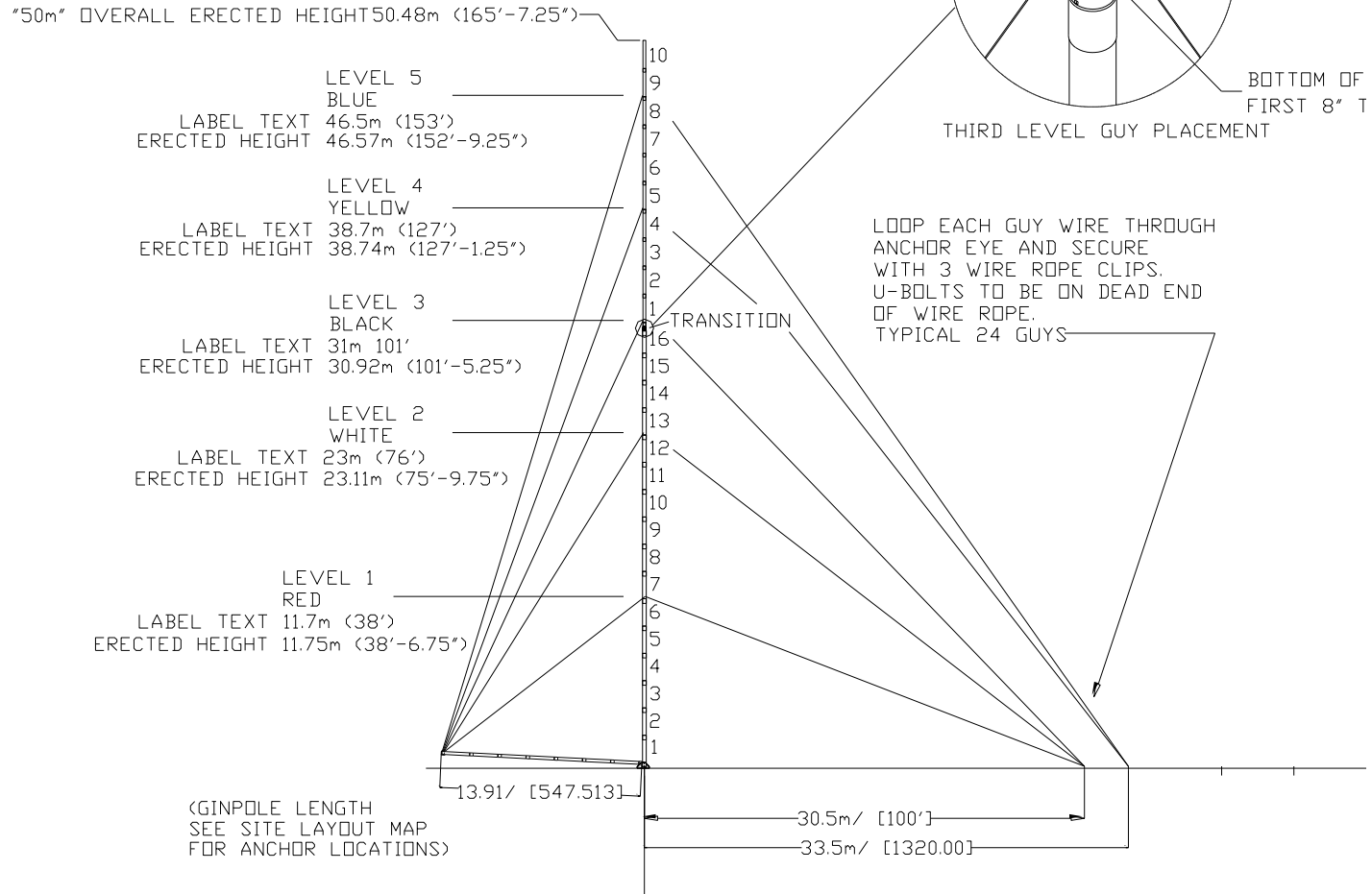
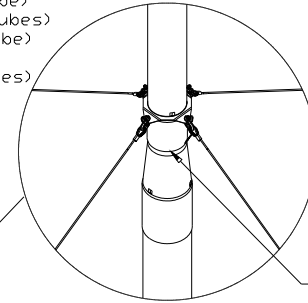

Site Layout

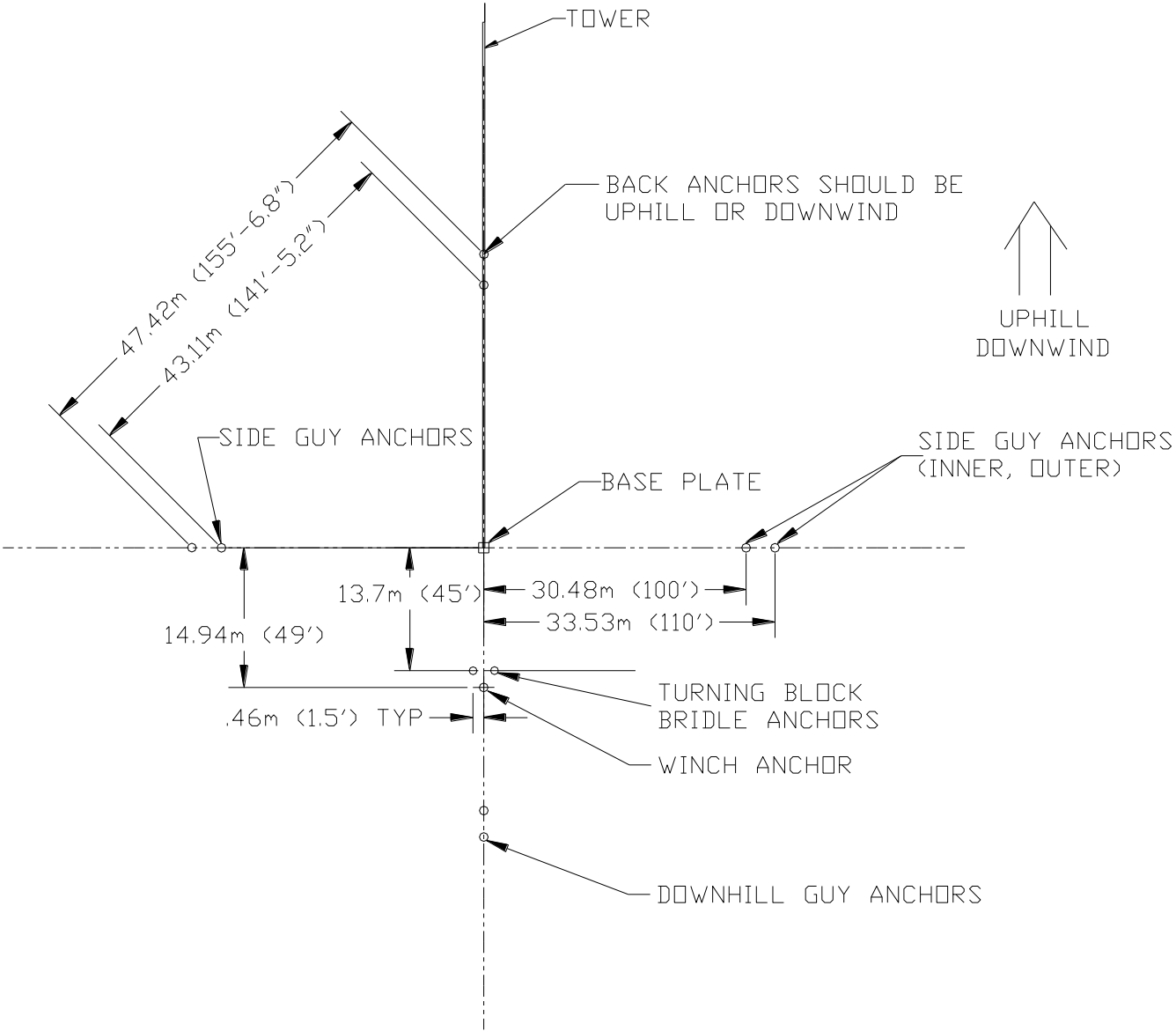

## Code Compliance Curve – Imperial Units

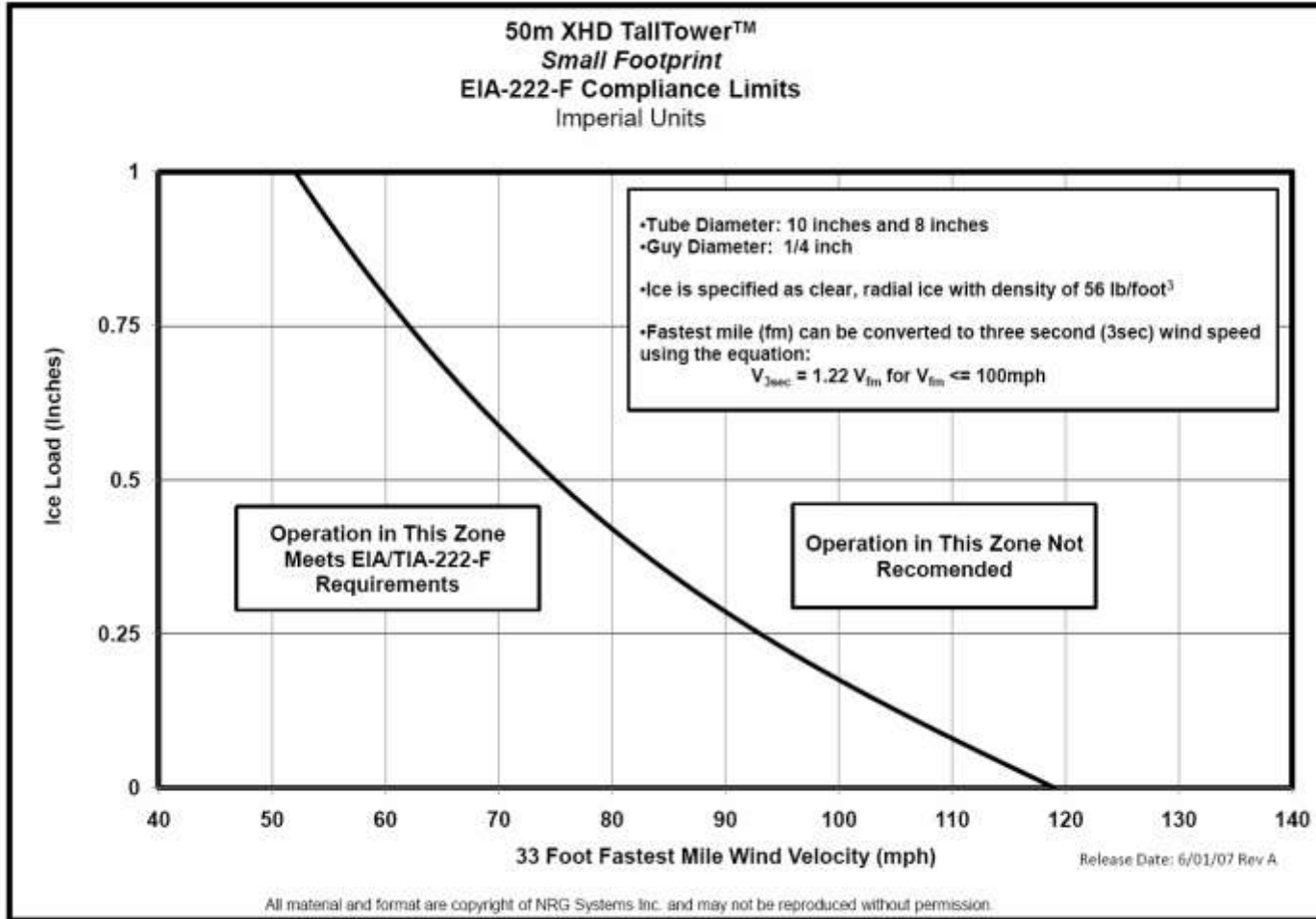

### Code Compliance Curve – SI Units

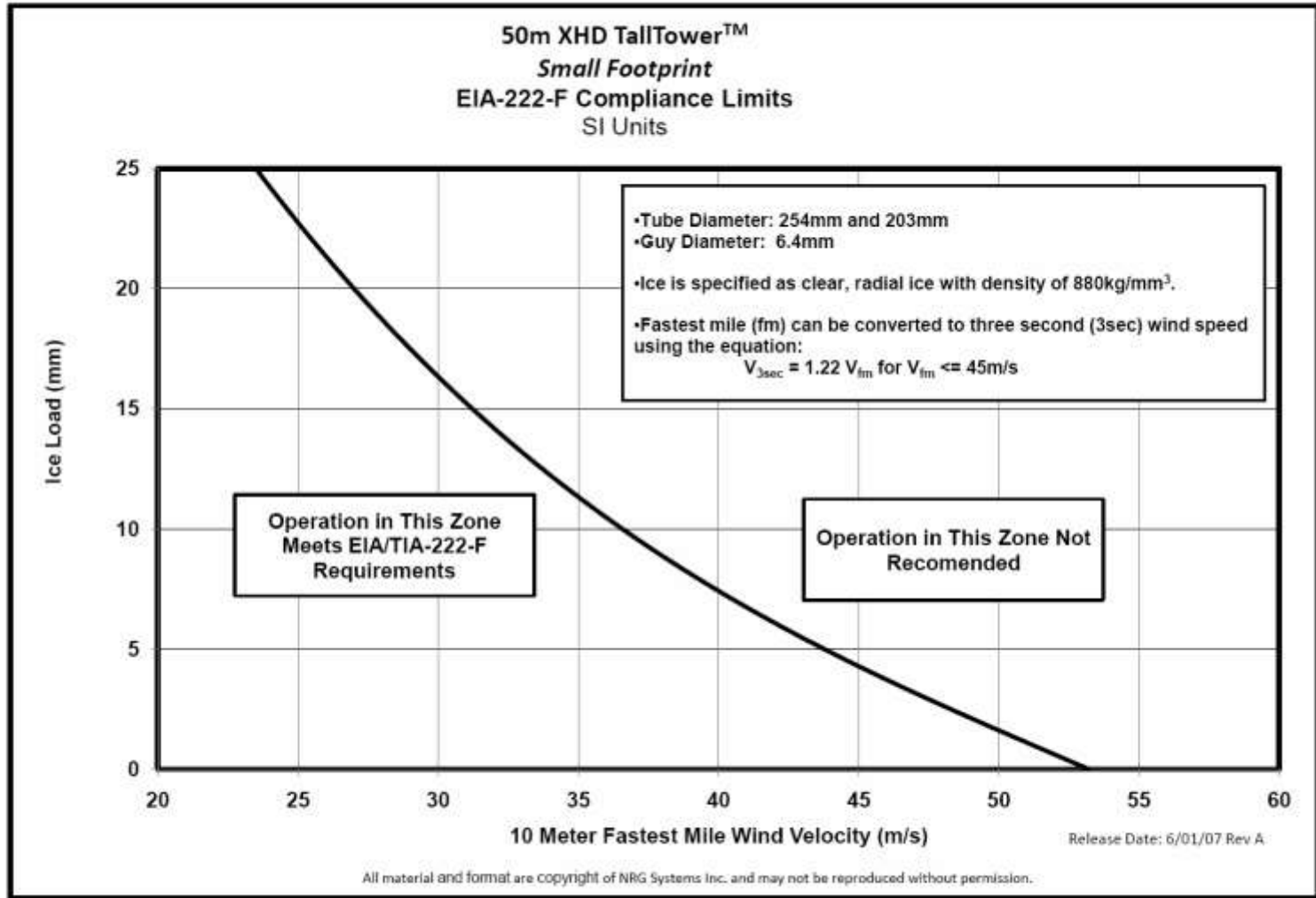





**Anchor Loads – Imperial Units** (The loads shown on the graph apply to each of the anchors)

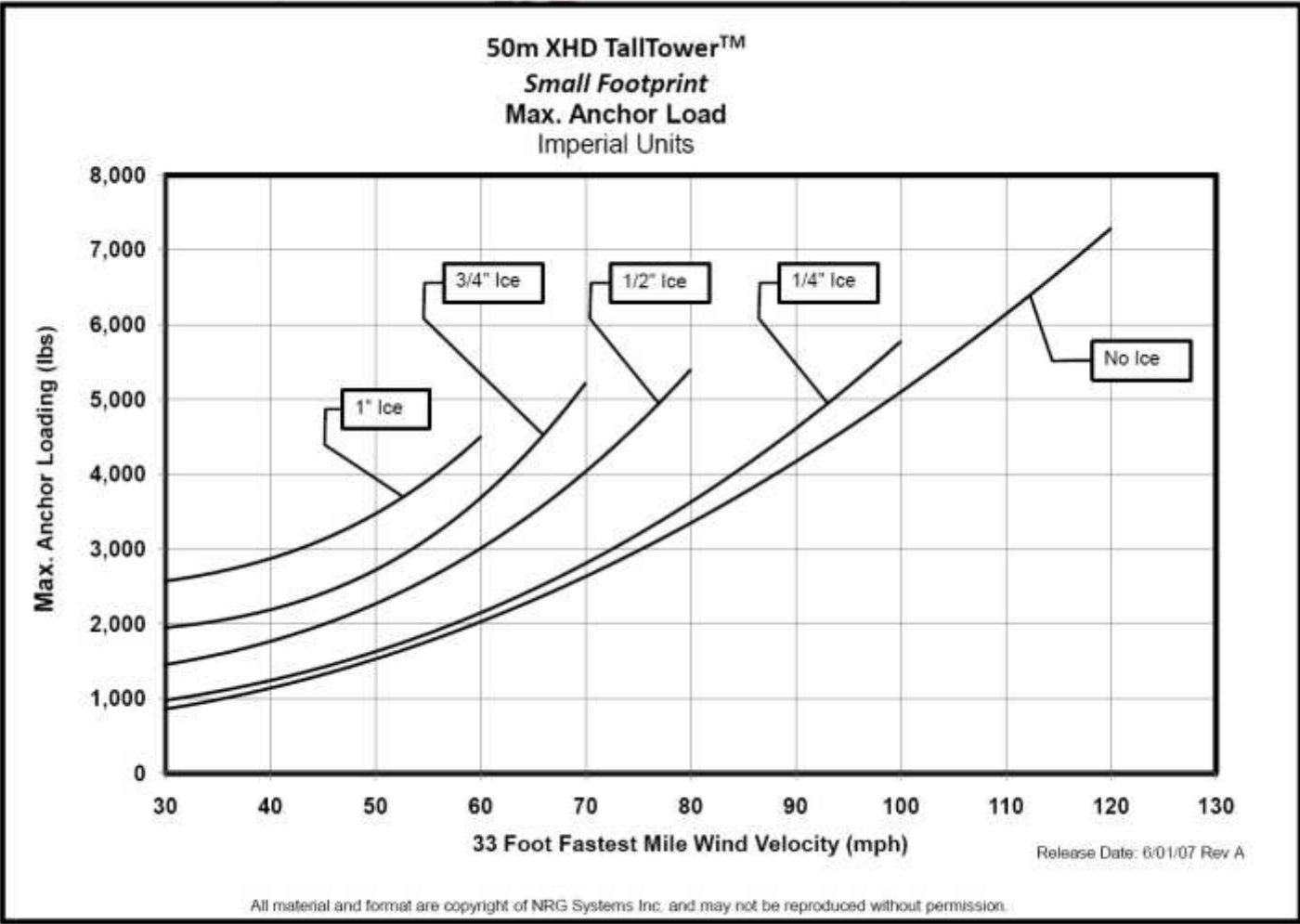

Anchor Loads – SI Units (The loads shown on the graph apply to each of the anchors)

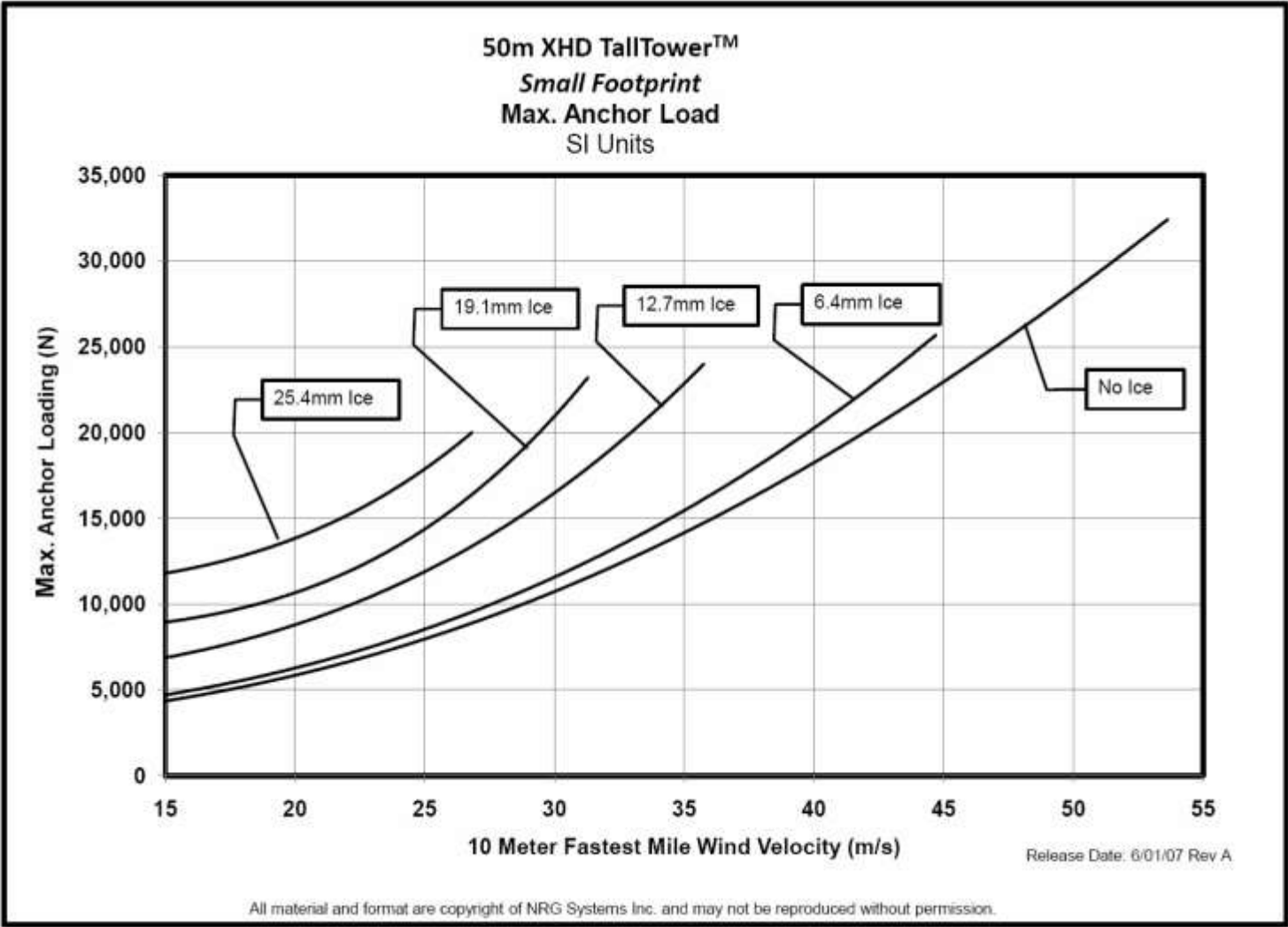

### Baseplate Loads – Imperial Units



### Baseplate Loads – SI Units

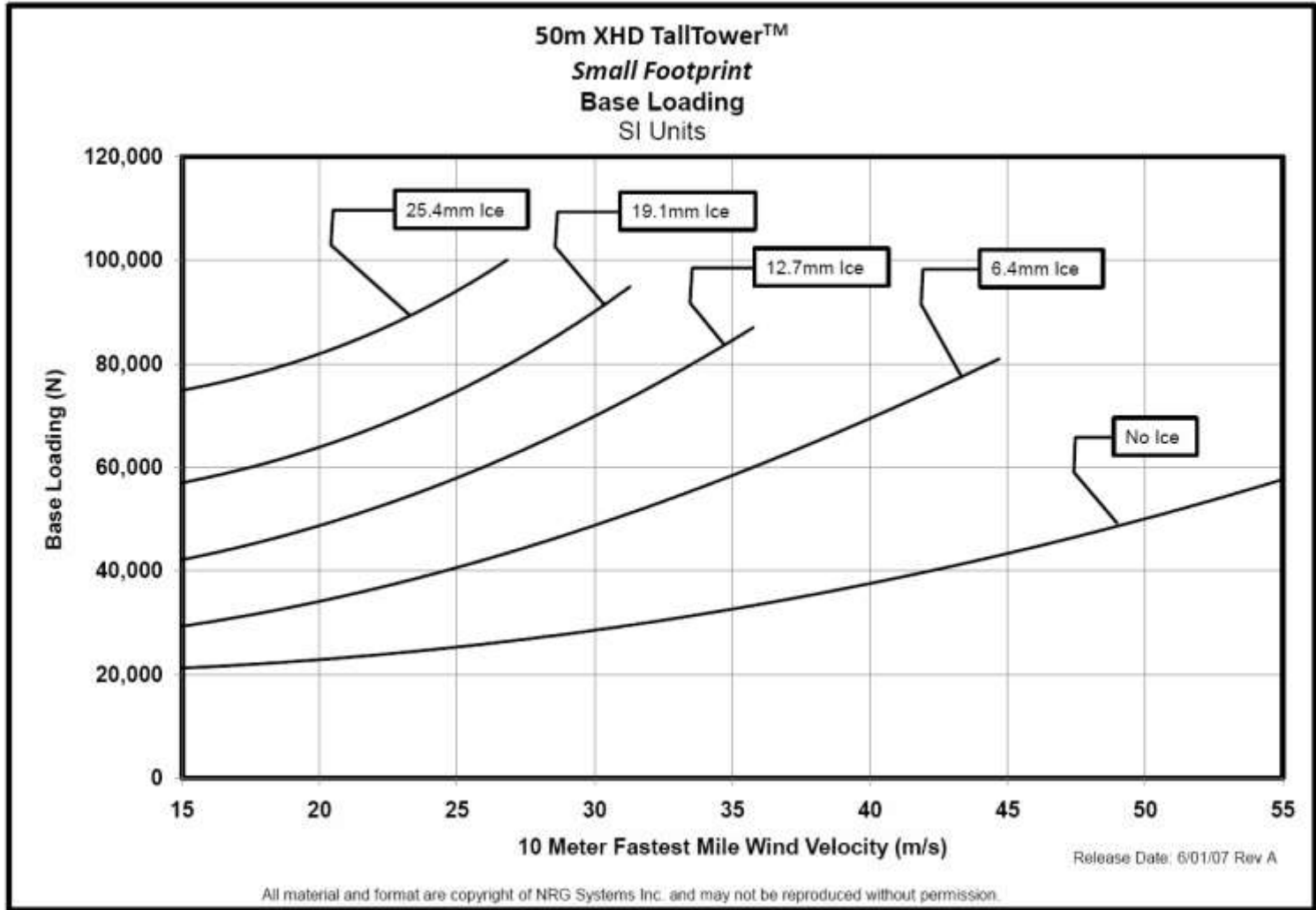

### Tower Erection Forces (tower only)

EIA-222-F wind velocity	Horizontal base reaction	Winch anchor reaction (b)
0 m/s (0 mph)	16.9 kN (3800 lbs.) (a)	23.1 kN (5200 lbs) @ 44° from Horizontal Load spread between the 3 anchors or 7.7kN (1733 lbs) per anchor

### Tower Erection Forces (with typical NOW System – 2 booms at 30 m, 3 booms at 40 m, 3 booms at 50 m, cables)

EIA-222-F wind velocity	Horizontal base reaction	Winch anchor reaction (b)
0 m/s (0 mph)	19.1 kN (4300 lbs.) (a)	26.2 kN (5900 lbs) @ 44° from Horizontal Load spread between the 3 anchors or 8.7 kN (1967 lbs) per anchor

Notes:

- a) The maximum horizontal reaction occurs when the tower is just off the ground.
- b) Maximum force on the winch anchor during tower erection (occurs when tower is just above the ground).
- c) These values assume no safety factor.

## Baseplate Geometry

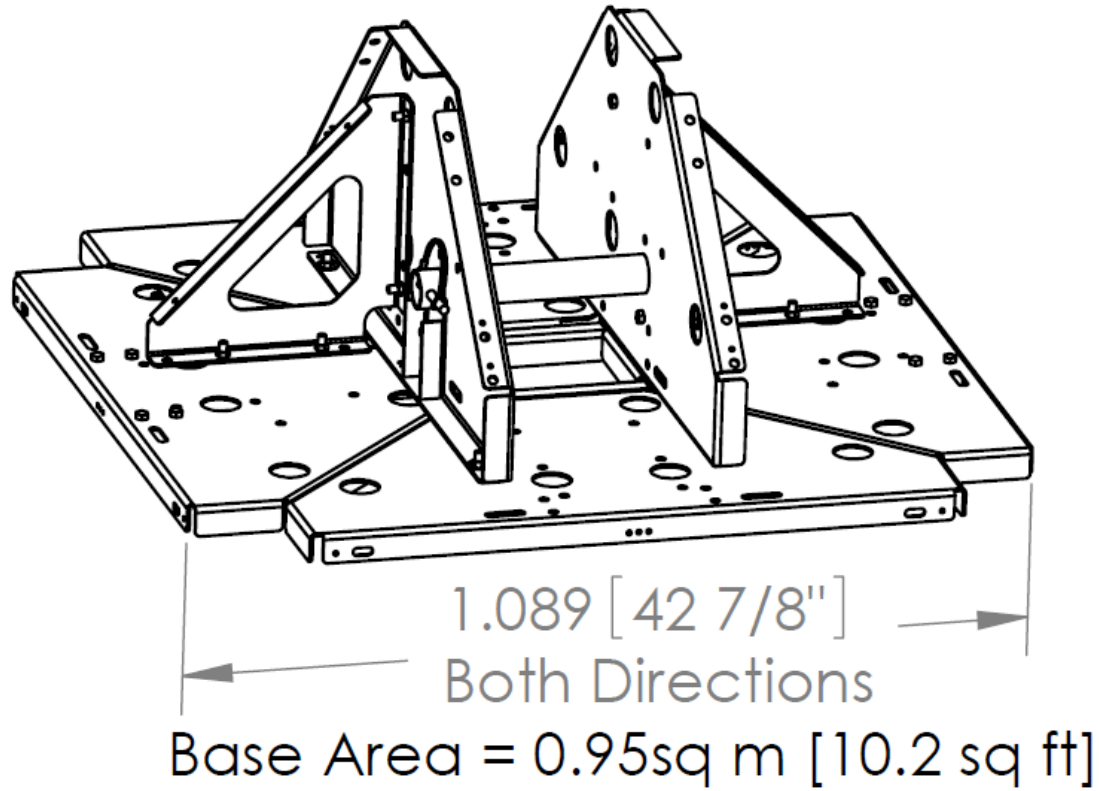



# 50m XHD with Small Footprint

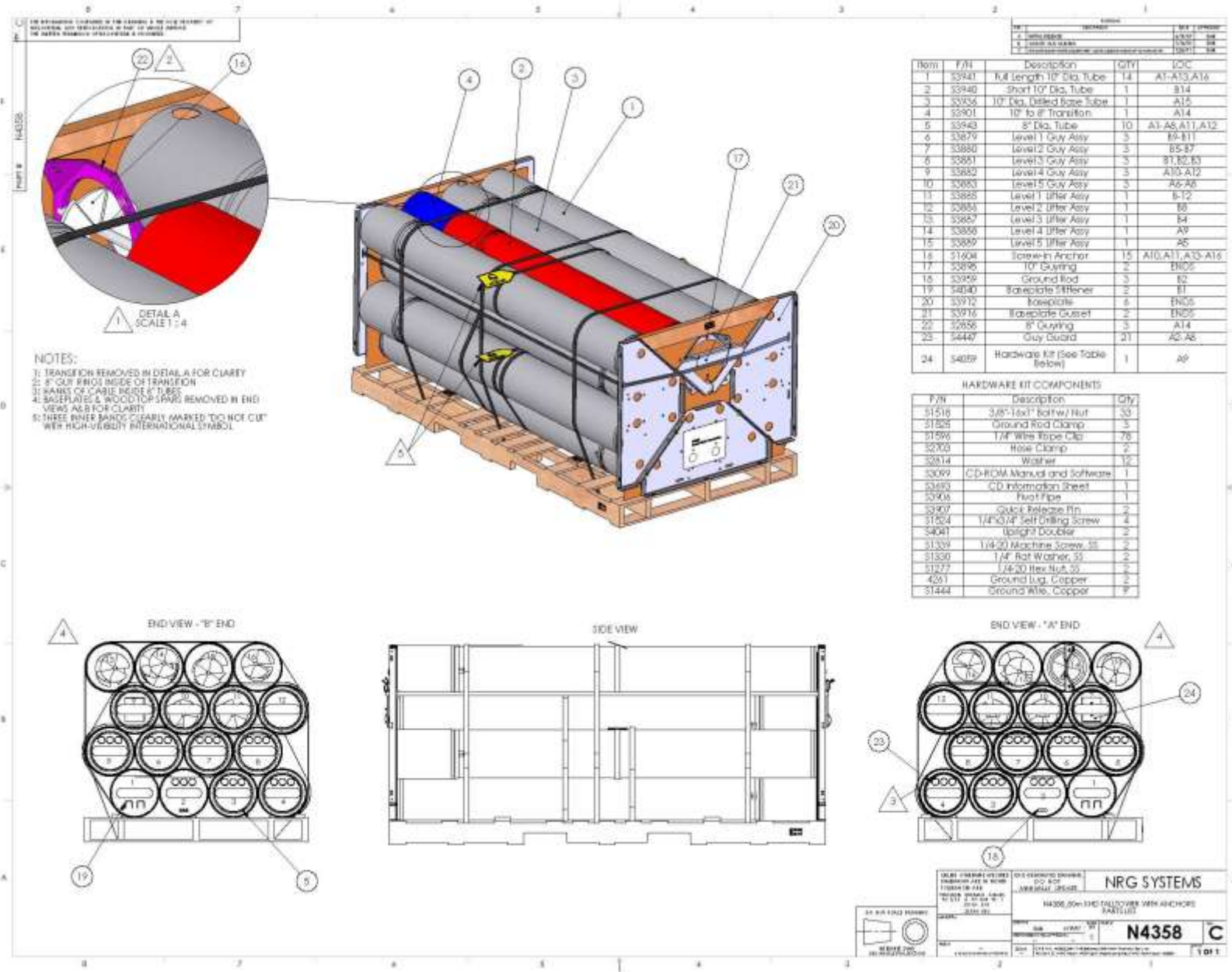

## Appendix H: Lightning Protection and United States FAA Height Compliance

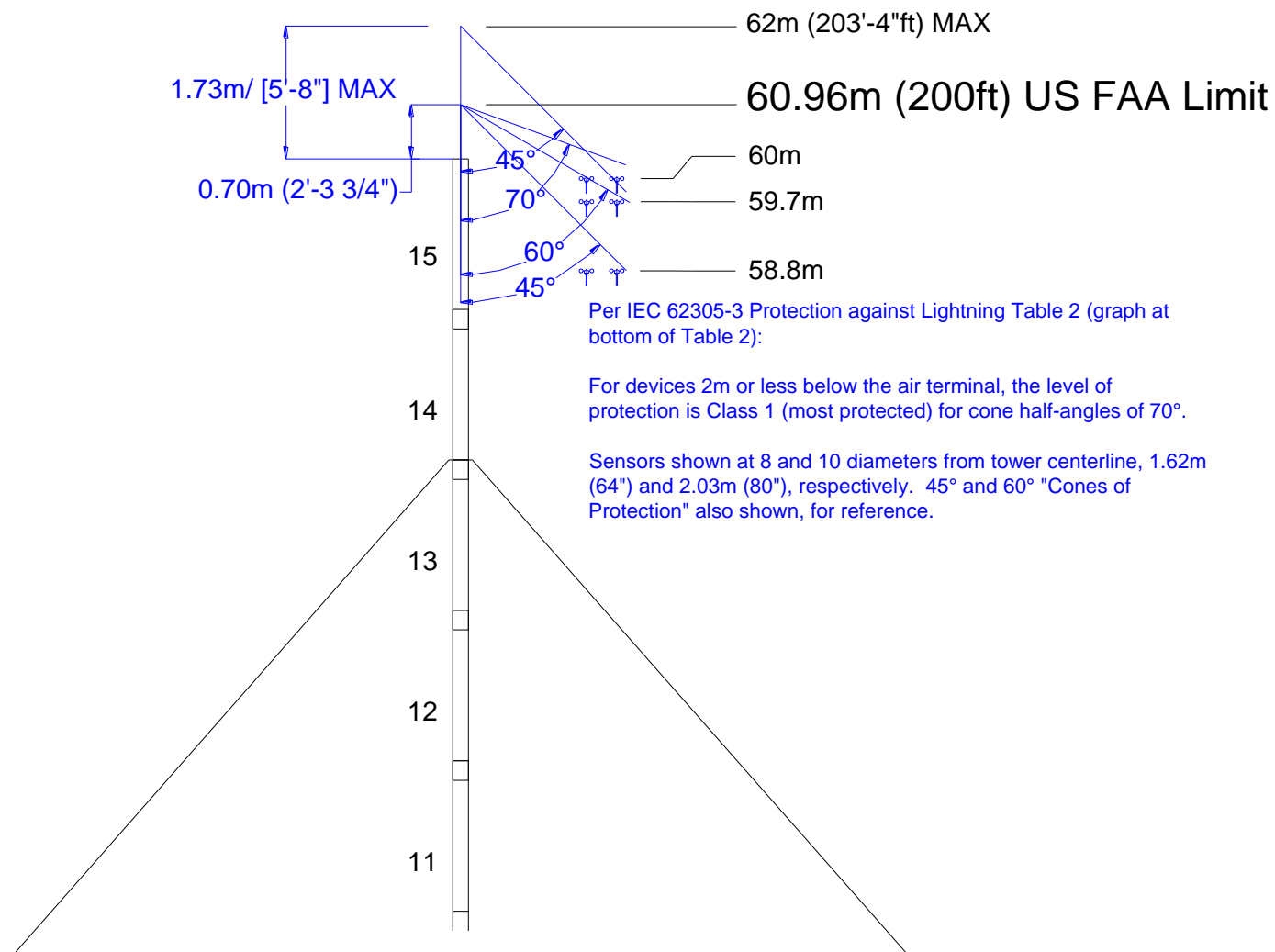

## Grounding NRG Tubular Towers

For towers or complete systems provided by NRG, the included equipment will provide adequate grounding for the tower and thus the instrumentation for most sites. The standard grounding equipment includes a copper-clad lightning spike, copper ground wire, two copper-clad ground rods, and a 3 m insulated ground cable for the data logger.

### Instructions

1. Drive two copper clad ground rods into the ground at the base of the tower. Make sure they are at least 2 meters apart from each other.
  - To reduce soil resistivity use longer ground rods, and/or install additional ground rods.
  - If multiple ground rods are used, they must be installed far enough away from each other (at least 2 meters) so that each rod's effective resistance area does not overlap.
  - Where rock is encountered, drive the ground rod at a 45 degree angle or bury it in a trench at least 0.6 m deep. Additional contact surface helps and conductivity improves with depth.
  - Where the soil can become frozen, drive ground rods below the frost line.
2. Affix a 5/8" acorn clamp to each of the ground rods. Clamp one end of the bare copper wire to the acorn clamp and the other end to the tower's base plate, passing through each additional ground rod's acorn clamp along the way as shown below.
  - Ensure that the ground rods are free from non-conducting coatings such as paint or enamel.
  - If multiple ground rods are used, wire them together to provide electrical continuity.
3. Connect the logger's ground cable to the 5/8" acorn clamp on the ground rod and cut any excess ground cable past the connection point; do not roll or coil any excess length of ground wire.
4. Apply an anti-oxidation agent to all grounding connections.

Mount all sensors below the 45° cone created by the lightning rod for the best protection

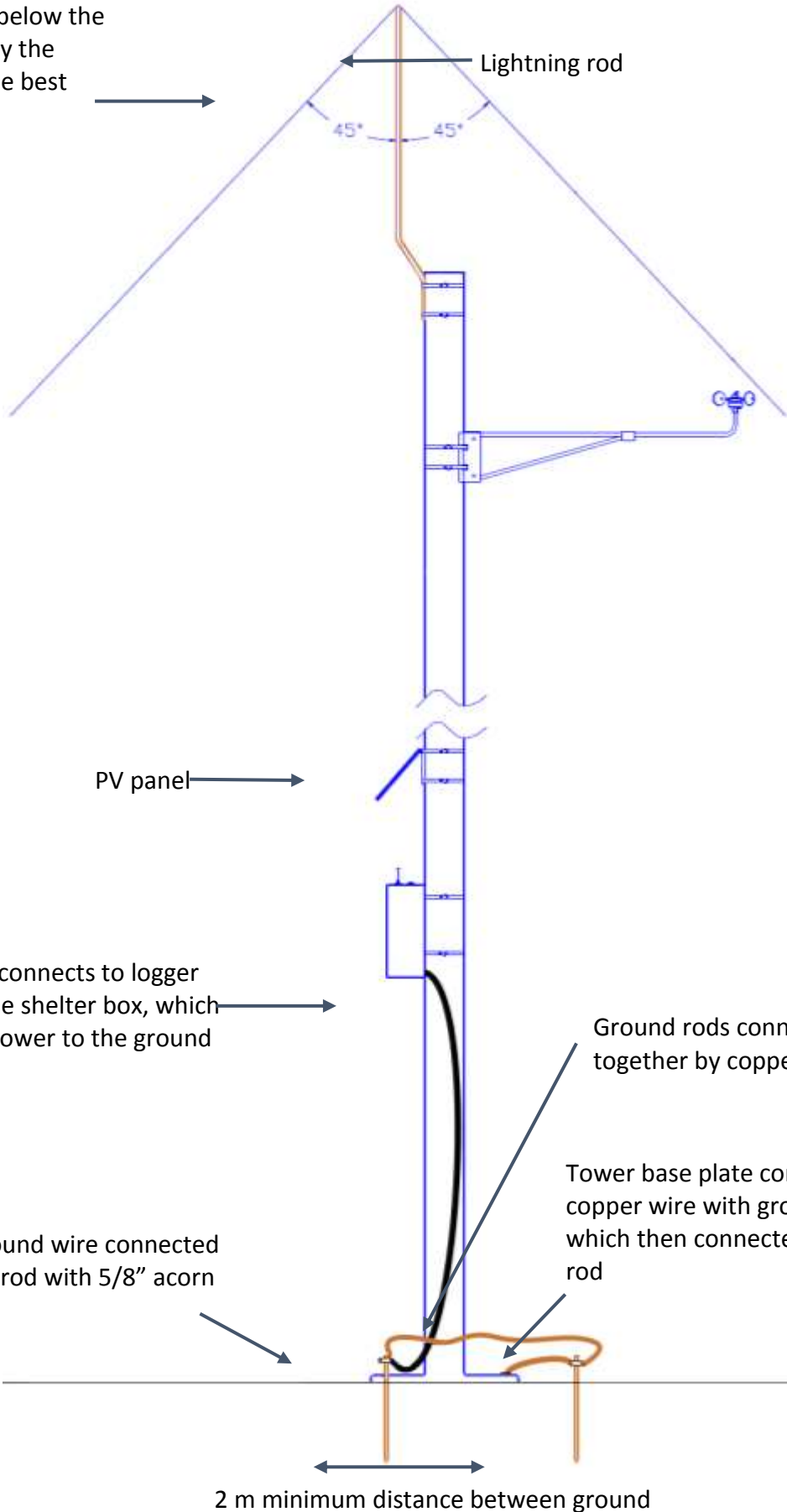

## Appendix I: Anchoring Guidelines

### Determine site soil and anchor type before you order your tower

Because anchor requirements are site specific, it is the responsibility of the customer to determine anchor requirements. If you are not sure what is required, seek professional guidance.

Before the tower is ordered, the soil type should be determined and the correct anchors ordered. The purpose of this section is to give you the information needed to provide suitable anchoring for your TallTower.

Local utility companies can often provide useful information regarding anchoring used in the site area. Do not use rebar anchors, especially when the surface soils are loose or wet.

**Table 6: Soil Classes**

<b>Class</b>	<b>Common Soil Types</b>	<b>Geological Soil Classification</b>
3	Dense clays, sands and gravel; hard silts and clays	Glacial till; weathered shales, schist, gneiss and siltstone
4	Medium dense sandy gravel; very stiff to hard silts and clays	Glacial till; hardpan; marls
5	Medium dense coarse sand and sandy gravels; stiff to very stiff silts and clays	Saprolites, residual soils
6	Loose to medium dense fine to coarse sand; firm to stiff clays and silts	Dense hydraulic fill; compacted fill; residual soils
7**	Loose fine sand; Alluvium; loess; soil-firm clays; varied clays; fill	Flood plain soils; lake clays; adobe; gumbo; fill

\*\* In class 7 soils, it is advisable to place anchors deep enough to penetrate underlying class 5 or 6 soil. Charts reproduced by permission, The A.B. Chance Co.

### Anchor Choices and other considerations

The choice of anchors must take into consideration soil type, maximum winds expected, icing or other weather that may affect the tower, and a safety factor suitable for the location and to meet any legal requirements. Considerations include but are not limited to: tornadoes, hurricanes or typhoons, locations where very high winds are expected, potential for flooding or periodic soaking of the soil, soil erosion, and icing events.

### ***Screw-In Anchor description***

Screw-in anchors are the most commonly used anchors for normal clay soils without rocks. They are installed by hand, using a cross bar to screw them into the earth like a corkscrew.

Screw-in anchors can also be used to provide the anchoring rod and eye for site-built anchors, such as concrete. Refer to the information on concrete anchors below. 150 mm (6.0 inches) diameter screw-in anchors are the standard anchors supplied with Renewable NRG Systems TallTowers. 203 mm (8.0 inches) diameters screw-in anchors are available upon request.

**Table 7: Specifications for 152 mm (6 inches) diameter Screw-In Anchors**

	<b>150 mm (6 inches) Anchor</b>
Helix diameter:	152 mm (6.0 inches)
Length Overall:	1.65 m (66 inches)
Rod diameter:	19 mm (0.75 inches)
Material:	Galvanized steel
<b>Holding Power:</b> (These anchors are not suitable for soils denser than class 5.)	
Class 5 soils *	3,000 kg (6,500 pounds)
Class 6 soils *	1800 kg (4,000 pounds)
Class 7 soils **	909 kg (2,000 pounds)

\* See **Table 6** for soil class descriptions

\*\* In class 7 soils, it is advisable to place anchors deep enough to penetrate to underlying class 5 or 6 soil.

**Table 7A: Specifications for 203 mm (8 inches) diameter Screw-In Anchors**

	<b>203 mm (8 inches) Anchor</b>
Helix diameter:	203 mm (8.0 inches)
Length Overall:	1.65 m (66 inches)
Rod diameter:	25 mm (1 inch)
Material:	Galvanized steel
<b>Holding Power:</b> (These anchors are not suitable for soils denser than class 5.)	
Class 5 soils *	44.5 kN (10000 pounds)
Class 6 soils *	31.1 kN (7000 pounds)
Class 7 soils **	17.8 kN (4000 pounds)

\* See **Table 6** for soil class descriptions

\*\* In class 7 soils, it is advisable to place anchors deep enough to penetrate underlying class 5 or 6 soil.



### **Arrowhead Anchor description**

Arrowhead anchors can penetrate stiff and rocky soils because the unique triangular design threads its way between obstacles such as rocks, which can prevent successful installation of screw-in anchors. Arrowhead anchors are driven into the ground with a hardened steel drive rod. Once in the ground, upward force on the attached cable rotates the anchor perpendicular to the cable for maximum holding power.

**Table 8: Specifications for Arrowhead Anchors**

Length Overall:	1.22 m (48.0 inches).
Arrowhead Length:	203 mm (8.0 inches)
Materials:	6.35 mm (0.25 inches) galvanized (7x19) steel cable; breaking strength - 1905 kg (4200 pounds); with malleable iron head.
<b>Holding Power:</b>	
Class 3 soils *	1905 kg (4200 pounds)
Class 4 soils *	1361 kg (3000 pounds)
Class 5 soils *	907 kg (2000 pounds)
Class 6 soils *	544 kg (1200 pounds)
Class 7 soils *	272 kg (600 pounds)

\* See **Table 6** for soil class descriptions

\*\* In class 7 soils, it is advisable to place anchors deep enough to penetrate underlying class 5 or 6 soil.

### ***Rock Anchor description***

Rock anchors are placed into solid rock, when anchoring to either bare rock, or thin soils with solid rock near the surface. They are constructed of a threaded rod with integral eye, and two opposing wedge halves. The anchor is placed in a hole pre-drilled in the rock. Twisting the eye of the anchor forces the wedges against the sides of the hole and locks the anchor in place. Load actually increases the wedging force, developing holding power equal to the full tensile strength of the rod.

**Table 9: Specifications for Rock Anchors**

Holding Power:	9072 kgf (20,000 pounds)
Rod Length Overall:	0.38 m (15 inches), 0.76 m (30 inches) or 1.35 m (53 inches), other lengths available
Anchor Diameter:	44 mm (1.75 inches) as supplied, 60 mm (2.375 inches) max. expanded
Rod Diameter:	19 mm (.75 inches)
Materials:	Malleable iron, dipped in rust-resisting black paint
Required Hole Size:	50 mm (2 inches) diameter (nominal)
Use Rock Drill Size:	50 mm (2 inches) diameter

### ***Concrete Anchor description***

The most common alternative anchoring system is to place site-built concrete anchors. A hole is excavated at the anchor position. Reinforcing steel is placed in the hole. A screw-in anchor is often tied into the reinforcing steel to provide a rod and eye above ground to attach the guys. Concrete is poured in place to form the anchoring mass, and the hole is then back-filled.

The anchors must be placed carefully to provide anchor points at the proper locations for the tower. **The holding power of concrete anchors is essentially due to their weight. The weight of concrete placed must exceed the required anchor holding force. Concrete anchors still depend on the soil to prevent the concrete mass from shifting toward the tower under load.**

Refer to the appropriate appendix for the anchor loads for your tower, and the angle of the guy wires from the ground. As with all anchoring systems, it is your responsibility to ensure that the anchors will perform as required. If in doubt, seek professional advice for anchor design.

## Installing Screw-In Anchors

Note: Unlike a tent stake, screw-in anchors are installed in line with the pull of the guy wires from the tower. It is important to install the anchor at an angle, so the eye of the anchor is toward the tower and the helix screws in away from the tower. If the anchor is incorrectly installed straight into the ground, the load will bend the rod and pull it through the ground, allowing the guys to go slack. Refer to the appropriate stamped drawing in the Appendix to determine the angle of the tower guys from the ground.

**Figure 9: Installing Screw-in Anchors**

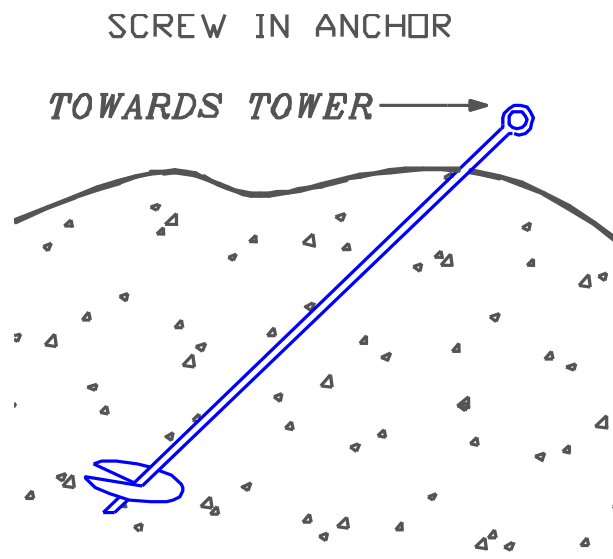

Screw the anchor into the ground by placing a stout bar through the eye of the anchor, and rotating clockwise. It is sometimes helpful to start the anchor into the ground straight down for the first turn, then push it down to the correct angle and complete the installation. Continue screwing the anchor into the ground until about 150 mm (6 inches) of the anchor rod remains above the ground.

If the anchor cannot be installed due to rocks in the soil, or other obstacles, try placing the anchor as much as 1 m (3 feet) from its ideal position to avoid the obstacle, or replace the screw-in anchor with the correct anchor for the soil. Arrowhead anchors are often suitable for rocky soils.

If necessary, a hole can be dug for the screw-in anchor to the proper installed depth, the anchor placed in the hole, and the hole back-filled. The earth must be tamped onto the anchor hard while back filling. The holding power of an anchor placed this way will not be as great as an anchor screwed into undisturbed soil. If in doubt, get professional advice on whether this option will work for your site.

## Installing Arrowhead Anchors

Arrowhead anchors are designed for all soils but are especially effective in rocky soils. The arrowhead anchor is driven into the soil with a drive rod. The rod is removed and the anchor is left in the ground.

Then the anchor must be pre-tensioned which will cause the anchor to rotate in the ground and develop its full holding potential.

Like screw-in anchors, the arrowhead anchor must be placed so the force from the guy wires pulls directly on the anchor. Drive the arrowhead anchor away from the tower at an angle into the ground. Refer to the appropriate stamped drawing in the Appendix to determine the angle of the tower guys from the ground.

Note: It is important to drive the anchor at an angle. If the anchor is incorrectly installed straight into the ground, the load will result in the anchor cable cutting through the ground until the angle is correct, resulting in significant slack in the tower guys, and possible tower failure.

**Figure 10: Installing Arrowhead Anchors**

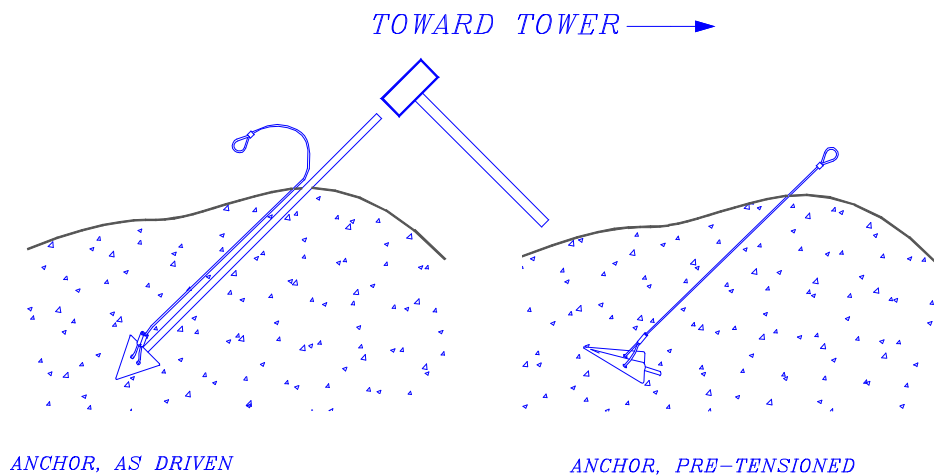

To install the anchor, place the drive rod over the anchor's shank. Drive the anchor into the soil using a sledgehammer, fence post driver, or power jackhammer, until the cable eye attached to the anchor is 50 mm (2 inches) to 100 mm (4 inches) above the surface of the ground.

After the anchor is driven, remove the drive rod, leaving the anchor in the ground. The anchor must now be pre-tensioned by applying strain to the cable. This can be done using a lever, come-along, jack, or winch. Pre-tensioning causes the anchor to rotate in the ground and develop its full holding power. The pull distance will be approximately the length of the anchor head, 203 mm (8 inches). The tension should become significantly higher as the pre-tensioning is complete.

Note: The anchor must be properly pre-tensioned before attaching the tower guys. If it is not, the tower guy wire tension will turn the anchor later, resulting in significant slack in the guy wires and possible tower failure.

## Installing Rock Anchors

Rock anchors are used when anchoring to either bare rock or thin soils with solid rock near the surface. Like any anchor, rock anchors must be placed so the force from the guy wires pulls directly on the anchor. Drill the hole for the anchor away from the tower at an angle into the ground.

Note: It is important to install the anchor at an angle, so the eye of the anchor is toward the tower and the expanding part of the anchor points away from the tower. If the anchor is incorrectly installed straight into the ground, the load will bend the rod and pull it through the ground, allowing the guys to go slack. Refer to the appropriate stamped drawing in the Appendix to determine the angle of the tower guys from the ground.

To install the anchor, a hole must be pre-drilled in the rock by hand or power tool. The hole must be 50 mm (2 inches) in diameter, and the walls of the hole should be smooth in the area that the anchor will wedge.

Place the anchor in the hole. Using a bar through the eye of the anchor, turn clockwise to tighten. The anchor will expand and wedge into the hole.

After placing the anchor, fill the hole around the rod with expanding cement grout. One brand is “Rockite” made by Hartline Products Co, Cleveland, OH, USA (telephone: +216 291 2303). Always grout rock anchors to prevent water from collecting and freezing in the drilled hole. Grouting also increases the anchor’s holding strength.

## Appendix J: Choosing a Winch and Ginpole

The 60m XHD TallTower requires a different ginpole and winch from all other NRG Systems towers. Please consult the table below for the recommended NRG Systems parts and their part numbers.

60 meter XHD Tower	Required Ginpole	Recommended Winch	Installation Kit
4042	3930	4254	3931

**Table 10**

50 meter XHD Tower	Required Ginpole	Recommended Winch	Installation Kit
4046	3930	4254	3931

**Table 11**

The NRG Systems winch item 1999 can be upgraded to be compatible with the XHD towers by purchasing the winch upgrade kit 3968.

The 60m XHD tower and ginpole are designed to be used with a three way pulley system (included with winch or #3968 upgrade kit).

Warning: Use of ginpole and pulley system other than specified may result in injury or death.

\*The 60 m HD ginpole (sold August 2006 through August 2007) is also compatible with the XHD towers; the 60 m XHD ginpole is compatible with the 60 m HD tower.

## Appendix K: Structural Analysis

### OBJECTIVE:

The objective of the analysis is to estimate the anchor reactions, member stresses and structural code compliance for the NRG Systems TallTowers, when subjected to high wind speeds and ice loading.

### IMPORTANT NOTE:

It is important to remember that the purpose of this analysis is to provide insight, not exact numbers. All modeling and analysis include assumptions and approximations to the actual hardware. The computed results have been checked and are believed to be reasonably correct for the conditions stated.

A qualified professional should evaluate whether this analysis is applicable to your particular site and conditions.

### STRUCTURAL CODE COMPLIANCE

The performance of NRG Systems TallTowers is assessed using the provisions of EIA-222-F (1996) and AISC ASD (1989). These standards are accepted in the BOCA 1996 and ICBO 2000 building codes for use on guyed structures. For a complete copy of the TIA/EIA 222-F Standard, contact:

Global Engineering Documents, 15 Inverness Way East, Englewood, CO 80112-5704

In the U.S.A. or Canada, call: 1-800-854-7179

International callers: 303-397-7956.

Each municipality or region will have specific code compliance requirements. Local ordinances must be reviewed to determine if the Renewable NRG Systems analysis is acceptable.

Wind speeds are based on location, exposure, and probability of occurrence. EIA-222-F lists minimum Basic Wind Speeds for different areas of the country. Basic Wind Speed is the fastest-mile wind speed at 33 ft (10 m) above ground corresponding to an annual probability of 0.02 (50-year recurrence interval). A 50-year recurrence interval is typically used for weather loading. Note that the basic wind speed differs from the 3-second wind speed reported by the National Weather Service (NWS).

Wind speed and corresponding force are functions of the elevation above the ground, the diameter of the tower member or guy wire, and the three dimensional angle of the member or guy wire to the wind direction.

The EIA-222-F Standards defines equations for use on the guy wires, and specifies a slightly different form for use on the main tower tube. A detailed description of each of the variables listed below is contained in the text of EIA-222-F.

The EIA-222-F equations for wind speed, lift, and drag force on vertical tubes and guy wires due to wind are listed below.



Drag and lift force on inclined guy wires

$$F_D = q_z G_H C_D d L_C \quad (\text{lb}) \text{ [N]}$$

$$F_L = q_z G_H C_L d L_C \quad (\text{lb}) \text{ [N]}$$

$q_z$  = See below

$$G_H = 1.69$$

$d$  = Diameter of guy strand (ft) [m]

$L_C$  = Chord length of guy (ft)[m]

$\theta$  = Clockwise angle of guy to wind direction ( $\theta \leq 180^\circ$ )

$$C_D = 1.2 \sin^3 \theta$$

$$C_L = 1.2 \sin^2 \theta \cos \theta$$

Horizontal force on tube element

$$F = q_z G_H C_F A \quad (\text{lb}) \text{ [N]}$$

$G_H = 1.69$  for tubular pole structures

$C_F = 1.0$  for round tubular structures

$A$  = Projected area of tube normal to the wind

For round tubes this is element length \* tube diameter

Velocity pressure of wind at a given height is determined by

$$q_z = 0.00256 K_z V^2 \quad \text{for } V \text{ in miles per hour}$$

$$q_z = 0.613 K_z V^2 \quad \text{for } V \text{ in m/s}$$

Exposure coefficient

$$K_z = [z/33]^{2/7} \quad \text{for } z \text{ in ft}$$

$$K_z = [z/10]^{2/7} \quad \text{for } z \text{ in meters}$$

$V$  = Basic fastest mile wind speed (mph)[m/s]

$z$  = Height above ground (ft) [m]

The horizontal and vertical forces on a given element at a specified elevation are calculated using the above equations and are used in the finite element analysis described next.

## METHODOLOGY

The tower is modeled using the ANSYS Finite Element Analysis (FEA) method. FEA is a widely accepted method for analyzing stress, reactions and deformation in complex structures. ANSYS is one of the most widely accepted FEA programs in the world. The tower and guy wires are broken down into small sections called elements with the corresponding wind and or ice forces applied to each element. Elements are mathematical models of a physical structure that deform in the same fashion as the actual tower. The elements are combined mathematically using the finite element method to account for the

effect each element has on the entire structure. Tower models are solved using the non-linear large deflection model.

Tower elements are modeled as ANSYS PIPE 16 elements and the guy wires as flexible LINK 10 elements. Typical guy wire elements are 0.3m (12 inches) long and tower sections vary from 0.05 - 0.3m (2 inches - 12 inches) long. A typical 50-meter tower analysis will have over 4000 elements and up to 8000 loads. A given tower may be tested using 4 - 6 different loading conditions and design alternatives. This includes wind, ice, erection, and several different wind velocities in combination with ice.

Wind forces are calculated for each element using a proprietary program at the center of the element height using the equations given in the specific building or structural code. Variables in the wind force equation include basic 10 m wind speed, gust response factor, diameter (including ice diameter), element length, guy angle, coefficient of drag, height above ground, and alpha (shear factor). The load is then applied to each element.

The applied force due to wind, ice and weight of the structure is then combined in a load factor equation to determine what load to apply to the structure. For example, EIA-222-F has determined that the full 50-year wind speed is unlikely to occur at the same time as the maximum amount of ice, so it allows one to decrease the wind load by 25% when the wind with ice combination is analyzed.

After a tower has been analyzed the results are processed to assess the stress and structural stability of the tower. The ASD and EIA codes have allowable stress or strength limits depending on the specific code and type of member. Elastic deformation of the long slender tube elements is often the limiting factor in determining maximum allowable loads. Tube buckling is assessed using Euler's equation for elastic column buckling and the corresponding combined axial stress and bending stress equation in the ASD code. Appropriate factors of safety are built into each equation.

A tower is a flexible structure composed of tube elements and guy elements. The equations governing these elements are quite different and have different factors of safety that may change with geometry. For this reason there is no single factor of safety specified for a tower.

Using the stresses determined from the FEA analyses and taking into account such factors as axial stress, bending stress, unsupported length of the tower, maximum allowable stress, and the end conditions of the tube sections, our engineers have calculated if the structure is considered stable according to the specific code.

The applied loads are compared to a MathCAD spreadsheet of the various equations to validate the accuracy. The MathCAD model includes several different methods of applying loads. These are used to verify that the applied loads are realistic. NRG Systems also applies over 20 years of field experience in deciding if a given analysis is realistic.

An analysis is only as good as the assumed conditions of loading, assembly and structural behavior. The field installation team must ensure that the structure and any foundations are assembled properly. Tubes must be dent free and straight. Dented or bent tubes will significantly reduce the load carrying capacity of the entire structure. Guy wires must have the correct number of wire clips and not be over tensioned, and the foundations must be adequately designed for the site conditions.

## Notice of NRG Systems EIA-222-F Compliance

Please note: TIA/EIA Engineering Standards and Publications are designed to serve the public interest by eliminating misunderstandings between manufacturers and purchasers, facilitating interchangeability and improvement of products, and assisting the purchaser in selecting and obtaining with minimum delay the proper product for the particular need. Since EIA-222-F Standards apply to steel antenna towers and antenna supporting structures for all classes of communications services, NRG Systems has identified the specific standards that apply to NRG Systems TallTowers and outlined them below.

Paragraph numbers are per EIA-222-F nomenclature.

### 1. Material

#### 1.1.1.2 Tube materials are as follows

8" – AISI 1015 or 1020 (yield  $\geq$  45000 psi)

10" – AISI 1015 or 1020 (yield  $\geq$  45000 psi)

### 2. Loading

#### 2.1.2.2

Ice density for design is 56 lb/ft<sup>3</sup> (8.8 kN/m<sup>3</sup>).

#### 2.1.3.1

Basic wind speed is fastest mile wind speed at 10 m (33 ft) above ground corresponding to an annual probability of 0.02 (50-year recurrence interval). The appropriate basic wind speed for a given site must be determined on a site-by-site basis by the installer.

#### 2.3.1.2

Ice thickness varies and depends on specific geographic location and other site parameters. NRG Systems does not specify or recommend a design ice thickness.

#### 2.3.2, 2.3.3

Horizontal wind force is calculated using the following equations

$$F = q_z G_H C_F A \quad (\text{lb}) \quad [\text{N}]$$

$$q_z = 0.00256 K_z V^2 \quad \text{for } V \text{ in mi/h}$$

$$q_z = 0.613 K_z V^2 \quad \text{for } V \text{ in m/s}$$

$$K_z = [z/33]^{2/7} \quad \text{for } z \text{ in ft}$$

$$K_z = [z/10]^{2/7} \quad \text{for } z \text{ in meters}$$

$$G_H = 1.69 \text{ for tubular pole structures} \quad (\text{Gust response factor 2.3.4.2})$$

$$C_F = 1.0 \text{ for round tubular structures}$$

$$V = \text{Basic fastest mile wind speed (mi/h)[m/s]}$$

$$z = \text{Height above ground (ft) [m/s]}$$

#### 2.3.14

Guy loads are calculated using the following equations

$$F_D = q_z G_H C_D d L_C$$

$$F_L = q_z G_H C_L d L_C$$

$q_z$  = Per above equation (sec 2.3.3)

$G_H = 1.69$  (Gust response factor 2.3.4.2)

$d$  = Diameter of guy strand (ft) [m]

$L_C$  = Chord length of guy (ft)[m]

$\theta$  = Clockwise angle of guy to wind direction ( $\theta \leq 180^\circ$ )

$$C_D = 1.2 \sin^3 \theta$$

$$C_L = 1.2 \sin^2 \theta \cos \theta$$

### 2.3.16

Two load combinations are tested

$$F = D + W$$

$$F = D + 0.75W + I$$

The force due to the wind (W) is calculated per EIA-222-F Section 2.3.2, 2.3.14 above. The wind force for ice loading is calculated using the ice radius added to the guy or tower element radius. Dead load (D) is the gravity force due to the mass of the structure. Ice force (I) is the gravity force due to the weight of a uniform coating of ice on the structure. The wind force (W) is the vertical ( $F_L$ ) and horizontal ( $F_D$ ) force applied to the structure using the equations presented in section 2.3.14.

## 3. Stresses

### 3.1.1

NRG Systems uses American Iron and Steel Construction (AISC) Allowable Stress Design (ASD), 1989 to determine the allowable load due to wind or ice.

### 3.1.11-15

Element stability is considered using ASD equations for combined axial and bending loading. NRG Systems tower elements are considered to be slender elements per ASD (1989) and slenderness ratios range from less than 100 to greater than 170.

### 3.1.16

NRG Systems does not specify or recommend specific reinforced concrete foundation and guy anchor design details for a specific site.

## 4. Manufacturing

### 4.1.1

Manufacturing and workmanship are in accordance with commonly accepted standards of the structural steel fabricating industry.

### 4.1.2

Welding procedures are in accordance with the requirements of appropriate AISC or AISI specification.

## 5. Factory finish

### 5.1.1.1

Structural materials shall be galvanized in accordance with ASTM A123 (hot dip).

### 5.1.1.2

Hardware shall be galvanized in accordance with ASTM A153 (hot-dip) or ASTM B693 Class 50 (mechanical).

### 5.1.1.3

Guy Strand – Zinc coated guy strand shall be galvanized in accordance with ASTM A475 or ASTM A586.

## 7. Foundations and Anchors

NRG Systems does not recommend specific anchor or foundation details due to the variability of specific site conditions. It is the responsibility of the installer to determine the appropriate anchor or foundation design.

## 8. Safety Factors of Guy Wires

### 8.1.1

Guy wire connections are swaged at the top and use U-bolt clips at the bottom end of the guy cable. Allowable guy strength is calculated using a connection efficiency of 90 percent.

### 8.1.2

The safety factor of guys is calculated by dividing the published breaking strength of the guy or guy connection strength; whichever is lower, by the maximum calculated tension design load.

### 8.2.1

The minimum allowable guy safety factor is 2.0.

## 9. Pre-stressing and proof loading of guys

### 9.2.1

NRG Systems does not pre-stress or proof-load guy wires.

## 10. Initial guy tension

### 10.2 Reactions and member forces

NRG Systems towers are designed with low initial guy tensions as the towers are intended to be flexible. Galloping issues and slack taut problems have not been an issue in 20 years of field experience. Excessive initial guy tensions may reduce the loading capacity of the tower significantly. High initial guy tensions will not stop the leeward wires from going slack as the tower is designed to accommodate minor deflections.

## 11. Operational requirements

Section 11 does not apply, as NRG Systems towers are not intended for directional antenna mounting applications.

## 12. Protective grounding

Electrical grounding per the appropriate electrical or building code is the responsibility of the installer. NRG Systems does not specify or recommend protective grounding design details. NRG Systems does supply a ground system to protect the instrumentation installed on the tower.

### 13. Climbing and working

NRG Systems towers are not designed for climbing and must not be climbed when erect. NRG Systems towers must be lowered for safe maintenance or service.

### 14. Maintenance and inspection

#### 14.1.1

NRG Systems strongly recommends that maintenance and inspection be performed on a regular basis. Towers must be inspected after severe wind, ice storms, or other extreme loading events.

## Appendix L: Site Visit Procedures

### Site Checklist



When making a site visit, check the following:

- Make sure the tower is straight. Stand at the base of the tower and look up to identify any bowed sections or curves in the tower that may have developed since the tower installation. Carefully adjust guy wires as necessary to straighten the tower.
- Check guy wires for excessive slack and adjust as necessary. It is normal for guy wires to stretch over time, and it is especially important to adjust them before they are subjected to icing or high winds.
- Check each anchor for movement or loosening. A loose anchor can also cause excessive slack in guy wires.
- Check that mounting booms, cellular antennas, temperature sensors, etc. are securely attached.
- Confirm that all grounding connections on the tower and on the logger are secure and haven't corroded.
- Check instantaneous sensor readings on each channel of your data logger. Any sensor providing erroneous readings should be disconnected from the logger and tested independently and/or replaced. It is a good idea to always have spare sensors, memory cards, batteries, and a spare data logger!
- Change the data logger's batteries. Remember that batteries are cheap – it's better to change them prematurely rather than risk losing data!



# Appendix M: Glossary

Anchor eye		
Arrowhead anchor		

<p>Base tube</p>	
<p>Coupler plates</p>	

Coupler plate bolt and nut



Drive rod for arrowhead anchor



Ginpole base tube



Ginpole guy ropes



Ginpole safety cable



Ginpole top tube



Ginpole turning block bolt and nut; winch cable bolt and nut



Guy ring







Guy wire		
Hankmaster		
Helper ginpole sheave		



<p>Lifting wires</p>		
<p>Lifter transfer hoist</p>		
<p>Pivot pin or pivot pipe</p>		

<p>Quick release pin</p>		
<p>Rock anchor</p>		
<p>Screw-in anchor</p>		

<p>Shackle</p>		
<p>short tube</p>		
<p>Spacers</p>		

<p>Transition tube</p>		
<p>Ginpole top pulley (turning block) and bridle anchor pulley – <b>winch upgrade kit</b></p>		

Winch



Wire rope clip



## Appendix N: Hankmaster Tool for Unrolling Guy Wires

The guy wire and lifter coils can be unrolled using the convenient Hankmaster tool. A Hankmaster can be built from materials available from most hardware stores using a few simple tools.

### Materials

- 1x 41.5" (105.4cm) of 1.625" (4.127cm) OD PVC Pipe, cut into:
- 1x 17" (43.18 cm) section;
- 1x 15" (38.1 cm) section;
- 1x 5.5" (13.97 cm) section;
- 1x 4" (10.16 cm) section.
- 2x 90 degree PVC Elbow Socket Fittings 2" (5.08 cm) OD
- 1x PVC T Socket Fitting 2" (5.08 cm) OD
- 1x Squared Retainer Snap Safety Pin, 2.5" (6.35 cm) usable length
- 2x 28" (71.12 cm) diameter x 0.5" (1.27 cm) thick plywood
- 8x 0.375"-16x3.5" Hex Head Bolts (M10 x 90 mm)
- 8x 0.375"-16 (M10) Nuts
- 8x 0.625" OD x 1.5" length (10 mm OD x 90 mm length) Spacers

### Tools

- Saw
- Drill
- 0.375" (M10) drill bit
- 2x 3/8 (10 mm) Wrenches or equivalent
- PVC Adhesive (Used for all PVC pipe connections)

### Procedure

1. Connect (quantity 1) Elbow Socket Fitting (part #2) onto 17" (43.18 cm) section of 1.625" (4.1 cm) OD PVC Pipe (part #1a).
2. Connect T Socket Fitting (part #3) onto other end of 17" (43.18 cm) section of PVC pipe (part #1a).
3. Connect 15" (38.1 cm) section of PVC pipe (part #1b) onto T Socket Fitting (part #3) in line with the 17" (43.18 cm) section.
4. Connect other (quantity 1) Elbow Socket Fitting (part #2) onto other end of 15" (38.1 cm) PVC pipe (part# 1b).
5. Drill a hole through the 5.5" (13.97 cm) PVC Pipe (part #1d) 0.5" (1.3 cm) from the end of the pipe section.
6. Connect 5.5" (13.97 cm) PVC Pipe (part #1d) onto other end of the second Elbow Socket Fitting (part #2).
7. Drill two holes through the 4" (10.16 cm) PVC pipe (part #1d), through the same plane, 1.5" (3.8 cm) from the end of the pipe.



8. Cut a 3/8" slot from the end of the 4" (10.16 cm) PVC pipe (part #1d) through the holes (step #7).
9. Connect 4" (10.16 cm) PVC Pipe (#1c) into remaining point of T-Fitting (part #3).
10. Cut 2" (5 cm) holes through the center of the 2 plywood discs (part #5).
11. Drill (8) 3/8" holes evenly around the 2 plywood discs (part #5) with a 10.5" (26.7 cm) radius.
12. Place the (quantity 8) bolts (part #6) through the 8 holes drilled in one of the plywood discs (part #8).
13. On the bolts (part #6) on the other side of the plywood disc (part #8), place the (quantity 8) spacers (part #8) followed by the (quantity 8) nuts (part #7) tightened snugly.
14. Line up the holes on the other plywood disc (part #5), and put the two discs on the 5.5" (13.97 cm) PVC Pipe (part #1c).
15. Insert the Safety Pin (part #4) in the hole drilled through the 5.5" (13.97 cm) PVC Pipe (part #1c) to complete assembly.

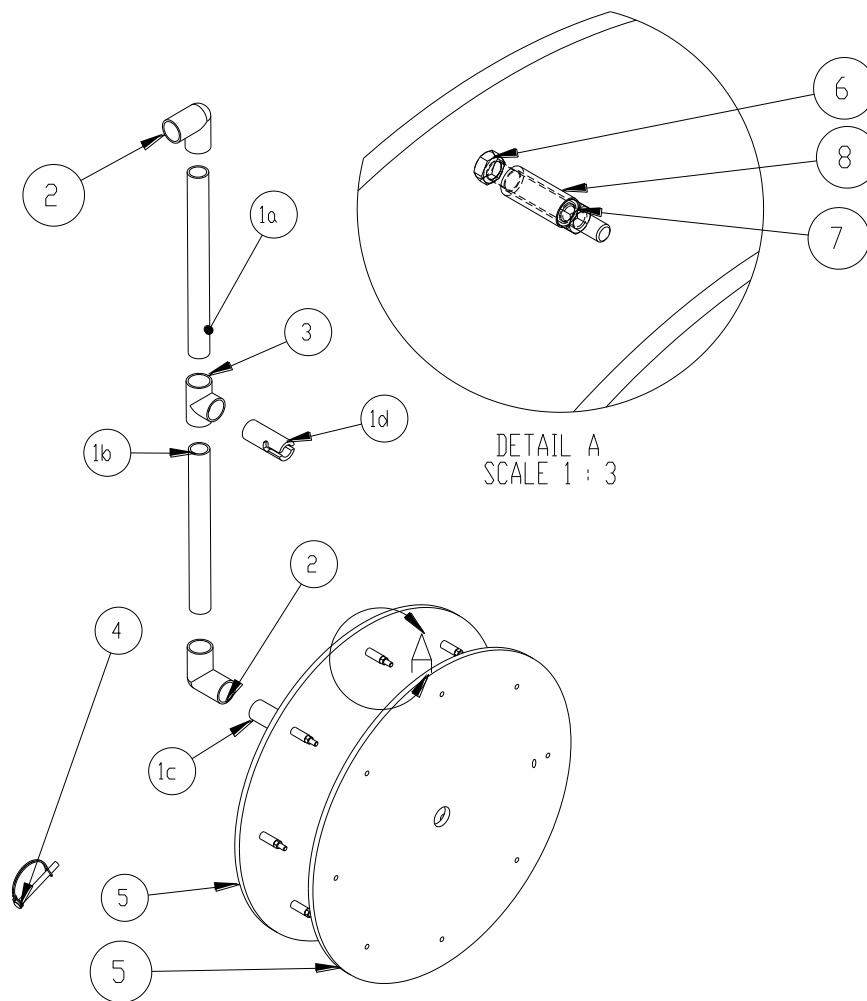

**Figure 1. Completed Hankmaster 5000™**

#### Usage

1. Unclip Safety Pin, remove from pipe.



2. Remove outer plywood disc.
3. Lay Hankmaster 5000™ on its side with the handle facing down.
4. Place coiled guy wire onto inner disc, around the 8 bolts.
5. DO NOT UNCLIP GUY WIRE COIL UNTIL YOU HAVE FINISHED ROLLING IT OUT TO THE ANCHOR.
6. Roll Hankmaster 5000™ to appropriate Guy Ring of tower.
7. Unclip guy wire coil; attach clip to guy ring.
8. Unroll guy wire coil to the appropriate anchor.
9. To re-coil a guy wire, simply thread guy wire through the angled hole in the outer plywood disc, and roll Hankmaster 5000™ over guy wire.
10. While rolling, guide guy wire through the wire guide above the plywood discs.
11. When coiling is complete, use a rubber band to hold the coil and prevent unspooling.
12. Lay Hankmaster 5000™ on its side with the handle facing down.
13. Remove coiled guy wire.

# Appendix O: 60m XHD TallTower Painted Version

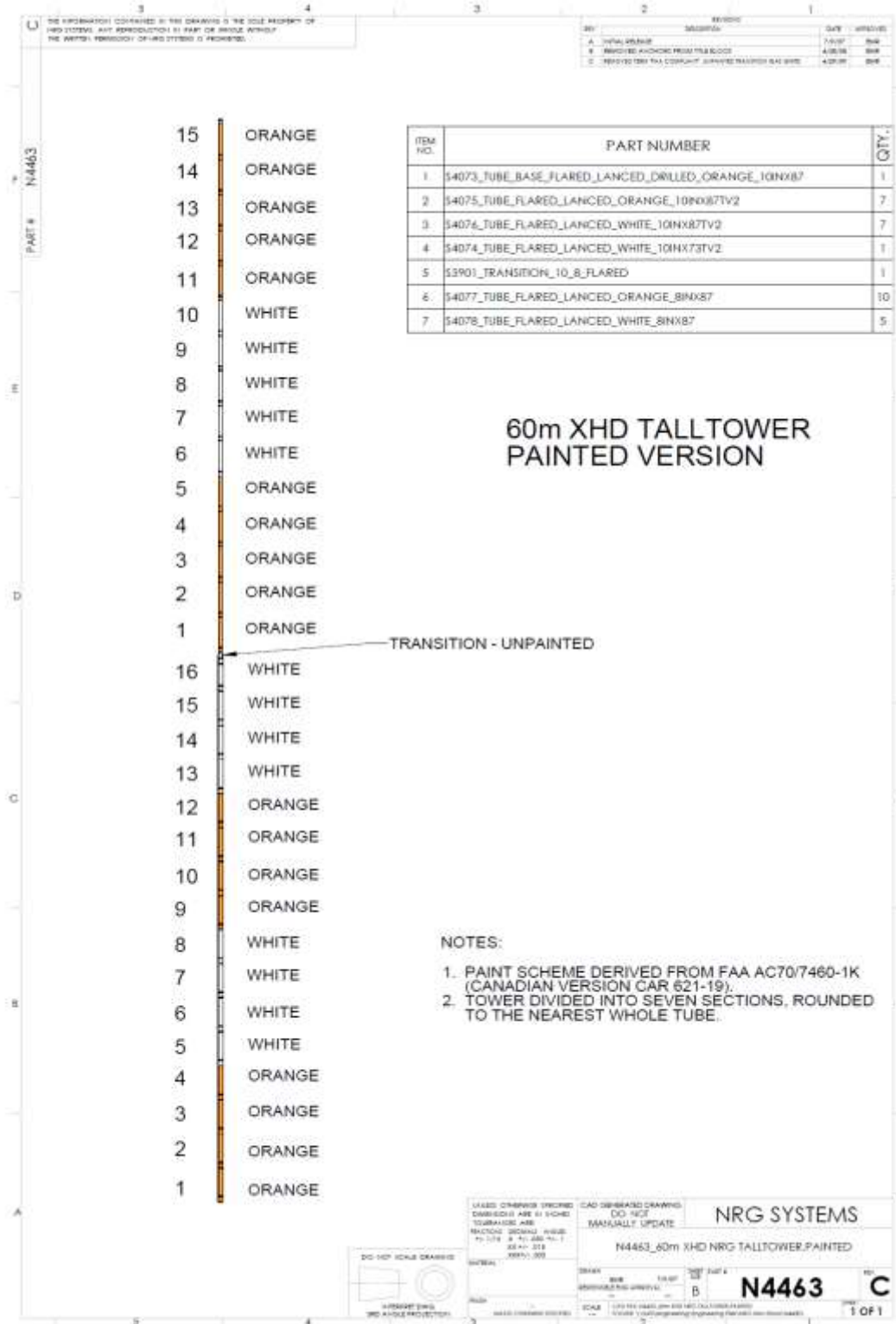

# Appendix P: 50m XHD TallTower Painted Version

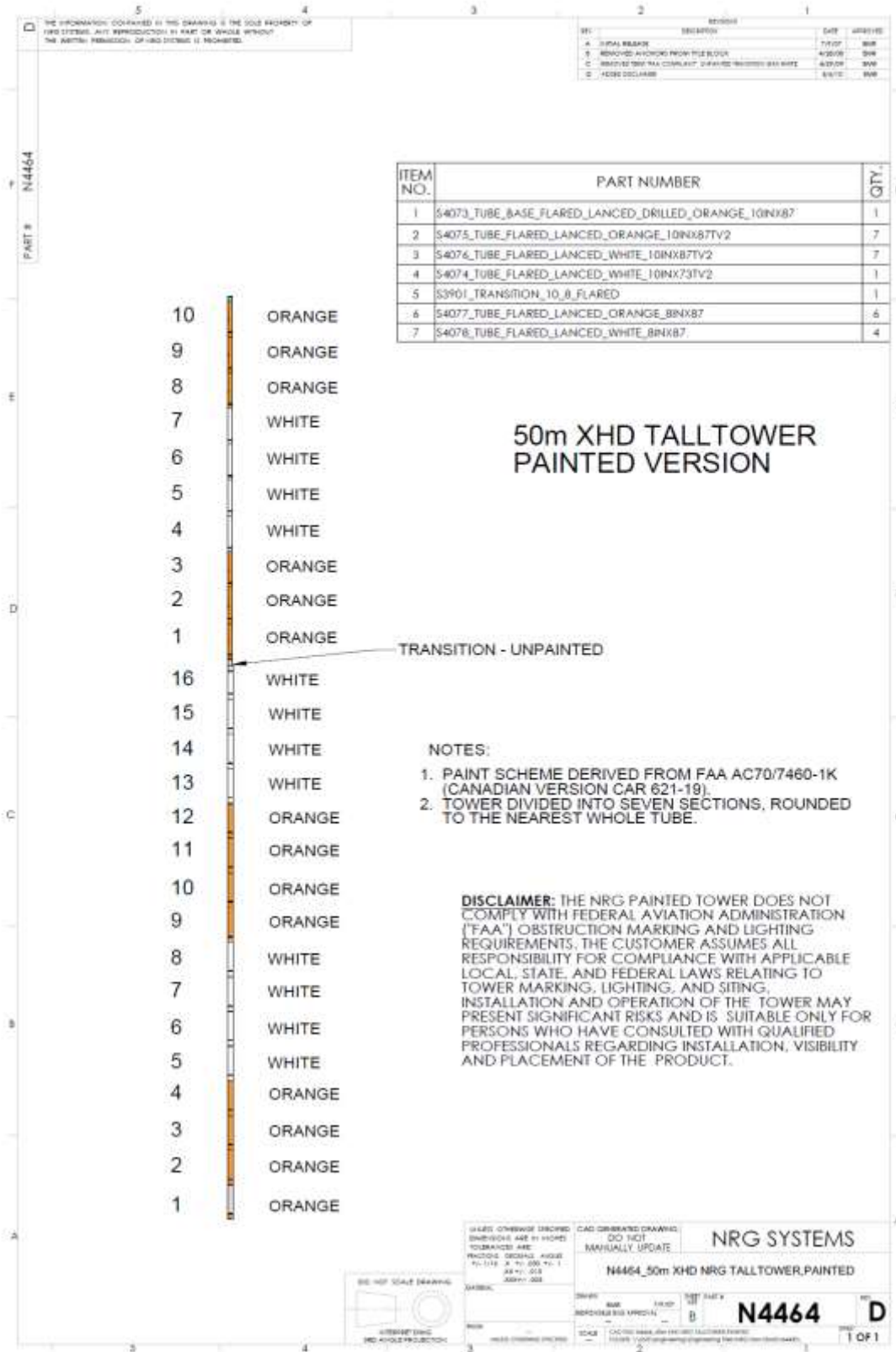

## Appendix Q: 2.4 m (95") Side Mount Boom Installation

### **Introduction**

Side mount booms are used to mount anemometers and wind direction vanes to Renewable NRG Systems TallTowers up to 10 inches in diameter. Made of galvanized steel, the 2.4 m (95 inches) boom resists corrosion and holds sensors away from tower to avoid tower shadowing effects. The 2.4 m boom provides horizontal offset of 2.54 m (100 inches) centerline to centerline on a 10" diameter tower (10D), and 2.5 m (99 inches) centerline to centerline on an 8" diameter tower (12.38D). ½ inch mounting stem is 6.5 inches high. Height of cup centerline is 0.38 m (15 inches) (20D) above the ¾ inch boom cross section.

### **Installation**

Step 1: Unpack box – 2 booms, 20 pieces total

Includes:

- 2 mounting brackets
- 6 hose clamps
- (2) 2-part triangular leg assemblies (Part A)
- 2 boom extensions with 90 degree bend – ¾ inch diameter tubing with ½ inch diameter stem shaft (Part B)
- 4 screws for mounting Part A to Part B (2 screws per boom)



Photo 1

Step 2: Affix Part A to Mounting Bracket

Place mounting bracket on ground or solid surface to install the 2 triangular 5/8 inch diameter boom sections. Line up the 90 degree bend with the large rectangular hole in the mounting bracket as shown in photo 2. The large hole in the mounting bracket will go towards the top of the tower.



Photo 2

### Step 3: Position Part A in mounting bracket

The tube will slide into the metal bracket with a firm downward push. There is a metal tab on what will be the bottom side of the mounting bracket - see photo 4 for a detailed photo of this tab. Push the 5/8 inch tube to the bottom of the mounting bracket so that the tube hits the metal tab as shown in photo 4.



Photo 3



Photo 4

### Step 4: Pre-Install the hose clamps into the mounting bracket

Select one hose clamp and feed the free end through one small side hole in the metal bracket, over the boom tubing and out the hole on the opposite side. Position the fastener opposite the mounting bracket

on the tower and with the hex head oriented towards you. Repeat 2 more times until all three clamps are in position.

**Step 5: Install boom on tower**

Using a 5/16 inch nut driver, attach the partially assembled boom to the tower. The section with 2 hose clamps will be toward the top of the tower. The hose clamps go around the bracket and the 5/8 tubing. Tighten the top and bottom clamps first, and then tighten the middle clamp. Photo 6 shows a detailed photo of the bottom clamp assembly. Please note the two metal tabs are toward the base of the tower.



Photo 5



Photo 6

**Step 6: Locate the 5-holed sleeve on the end of Part A**

The 2 holes for the #10-32 self-tapping screws should be toward the top of the tower. See photo 7.



Photo 7

**Step 7: Install Part B, boom extension**

Insert Part B into the 5-holed sleeve and align with the stem shaft pointing straight up as in photo 8.



Photo 8

### Step 8: Secure the boom extension

Line up the holes in the  $\frac{3}{4}$  inch pipe with the sleeve. Install the 2 x  $\frac{5}{16}$  inch drive self-tapping screws in the sleeve (photo 9). Using a drill driver and holding it straight helps to get these started correctly and is much more effective than a hand screw-driver.



Photo 9

Tighten the self-tapping screws to secure the boom extension as in photo 10. The clutch on the drill driver can be set to a low/medium setting and that will seat the screws correctly.



Photo 10

Photo 11 shows the finished new boom installed above the 1.53 m (60.5 inch) boom.



Photo 11



# Appendix R: NRG 60m XHD TallTower Back Guywire Tensioner Assembly and Operating Instructions

## R.1 Introduction

This procedure requires that during the assembly of the tower, the back guy wires are attached to their respective guy ring, rolled out alongside the tower and measured, then marked at the distances shown in Table S-1. Once marked, connect the back guywires to their respective back guy anchor so that the mark is at the triple eye of the anchor.

**Table R-1: Back Guywire Marking Distance from Guy Level**

Guy Ring Level	Back Guy Wire Length	Label Color
1	136.6 feet	Red
2	150.6 feet	White
3	178.4 feet	Black
4	184.4 feet	Yellow
5	223.5 feet	Blue
6	246.5 feet	Green

## R.2 Back Guywire Tensioner System Overview

The back guywire tensioner kit consists of two (2) independent systems each comprised of two (2) worm gear winches, tied to load scales and ganged together using a steel spreader bar. Each system is anchored to a six (6) inch diameter single helix screw-in anchor placed in-line with the outer side-guy anchor 50m [164' ± 2m [6'-7"]] from the tower base and 35m [114'-10"] ± 2m [6'-7"] in the direction towards the back anchors. The position of the back guywire tensioners is outside of the side guywire shadow and fall zone of the tower. One set of worm gear winches controls tension on back guywires 3 and 5; the other set controls tension on back guywires 2 and 4.

**Each** of two (2) back guywire tensioner system consists of the following parts:

- 6 inch diameter single helix anchors (1)
- Anchor wire rope assemblies (2):
  - Used to connect spreader bar to anchor
  - ¼" wire rope clips (4) used to attach wire rope to anchor
  - ½" shackles (2) used to attach thimbles to spreader bar
- Steel spreader bar (1)
- 0 - 500 lbf load scales (2)
- Worm gear winches (2)
- Leader lines (2)
  - Attach worm gear winches to back guywires using two (2) Easy-Feed pulleys
- 3/16" wire rope clips (4)

- Used to connect the Leader lines through pulleys attached to the worm gear winch cables

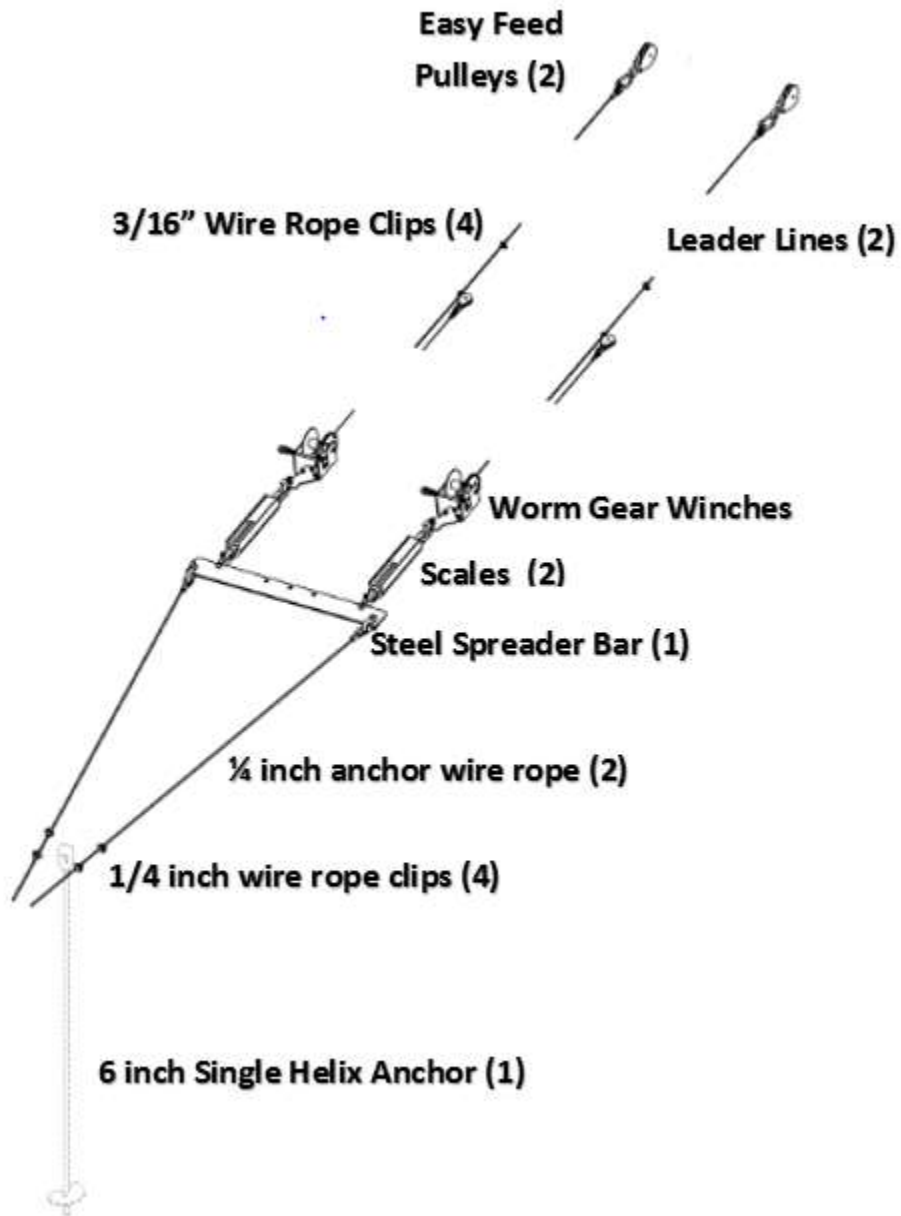

Picture R-1: complete set-up of one back stay tension system

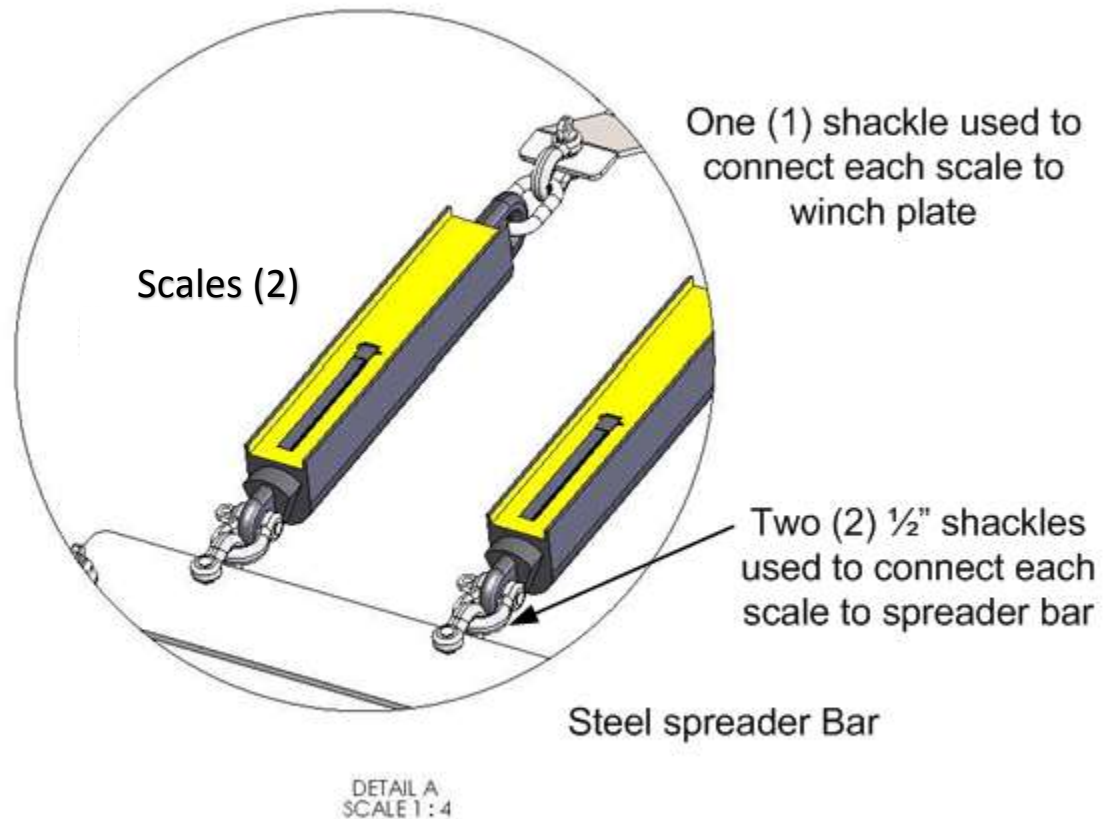

**Picture R-2: Zoomed view of scale connection to winch plate and spreader bar**

### **R.3 Back Guywire Tension Assembly**

A plan view of the tower layout showing the placement of the back guywire tensioners is included in Picture S-3. Install the two (2) 6 inch diameter single helix screw-in anchors in-line with the outer side-guy anchor 50m [164'] ± 2m [6'-7"] from the tower base and 35m [114'-10"] ± 2m [6'-7"] in the direction towards the back anchors.

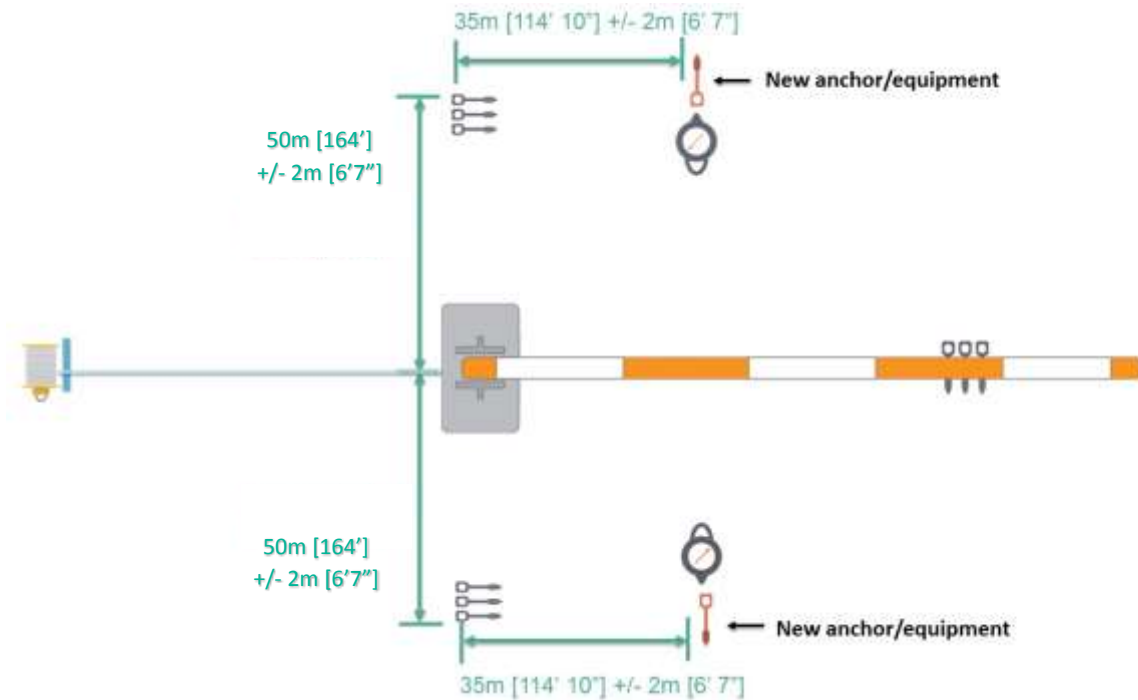

**Picture R-3: Layout drawing showing placement of Back Guywire Tensioners/anchors**

Perform the following set-up instructions:

- Attach the steel spreader bar to the 6 inch diameter anchors using the supplied 1/4" diameter anchor wire rope assemblies and 1/2" shackles.
- Attach the load scales and worm gear winches to the steel spreader bar. Make sure that the scales are set to zero using the adjustment mechanism. Make the zero adjustment with the scale oriented horizontally.
- Roll out leader cables and attach to back guywires using the supplied easy-feed pulleys. Picture R-4 shows the connection of the easy-feed pulleys to the back guywires (disregard the angular position of the tower in the photograph – your tower is on the ground at this point in the lift).
- Leader cables can be installed during initial layout, before lift. Leaders will have to go under all side guys and not over any side guys, front guys, or lifters.



**Picture R-4: Leader cables attached to back guywires using pulleys**

#### **R.4 60m XHD Tower Lift**

The tower lift consists of two (2) distinct phases:

- Phase 1: Tower Lift from 0° to 70°
- Continuous lift
- Phase 2: Tower Lift from 70° to 90°
- Incremental lift
- A graphical depiction of the two (2) phases of the lift is depicted in Picture Q-5.
- Below is a detailed description of each the the two (2) phases.

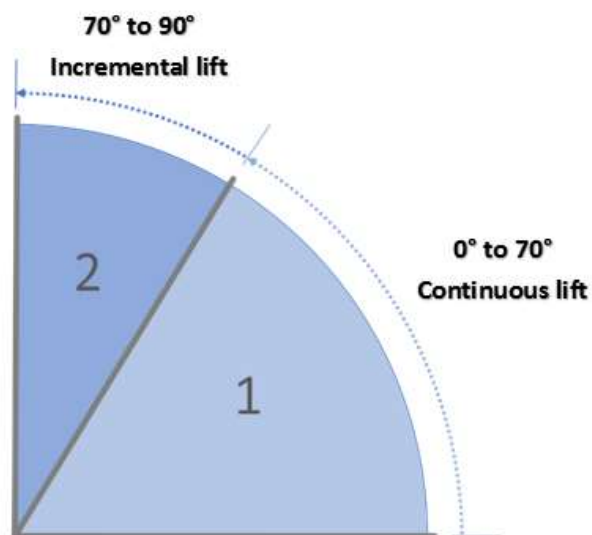

**Picture R-5: Phases of the 60m XHD TallTower lift**

#### **R.4.1 Phase 1: Tower Lift from 0° to 70°**

Raise the tower from 0° to 70° following the same procedure described in the NRG Systems 60m XHD TallTower™ Installation Manual & Specifications.

#### **R.4.2 Phase 2: Tower Lift from 70° to 90°**

Above 70° from horizontal, the tower is raised incrementally using the Back Guywire Tensioner system following a revised Lift Cycle described below. The worm gear tensioners replace personnel applying resistance using ropes and carabiners to the back guywires. The Back Guywire Tensioner system also replaces the Lift-Slack (i.e., “Inch-Worm”) method.

Allocate the crew to perform the following tasks:

- Crew Leader (1) to monitor and supervise the tower lift and monitor back guy wire tension at end of lift
- Crew member to monitor and control worm gear winch back guywire tensioners (2)
- Crew member to monitor and control side guywire tension (2)
- Crew member to operate winch (1)

When the tower is at 70 degrees from horizontal, stop the lift. As shown in Picture R-7, attach the leader lines to the worm gear winches using the following instructions:

- Using a cordless drill with a ¾” nut driver, reel out the worm gear winch line about 10 feet and attach the leader cable.
- Feed the leader line cable through the easy-feed pulley affixed to the worm gear winch. Keep some tension on the winch line to prevent unspooling.
- Remove slack and secure the leader line with the supplied wire rope clips. Run winch as-required to place tension (50 ± 10 lbf) on the cable. Attach all four (4) worm gear winches in the same manner. Refer to Picture T-7 and Picture R -8, for graphical and pictorial details.

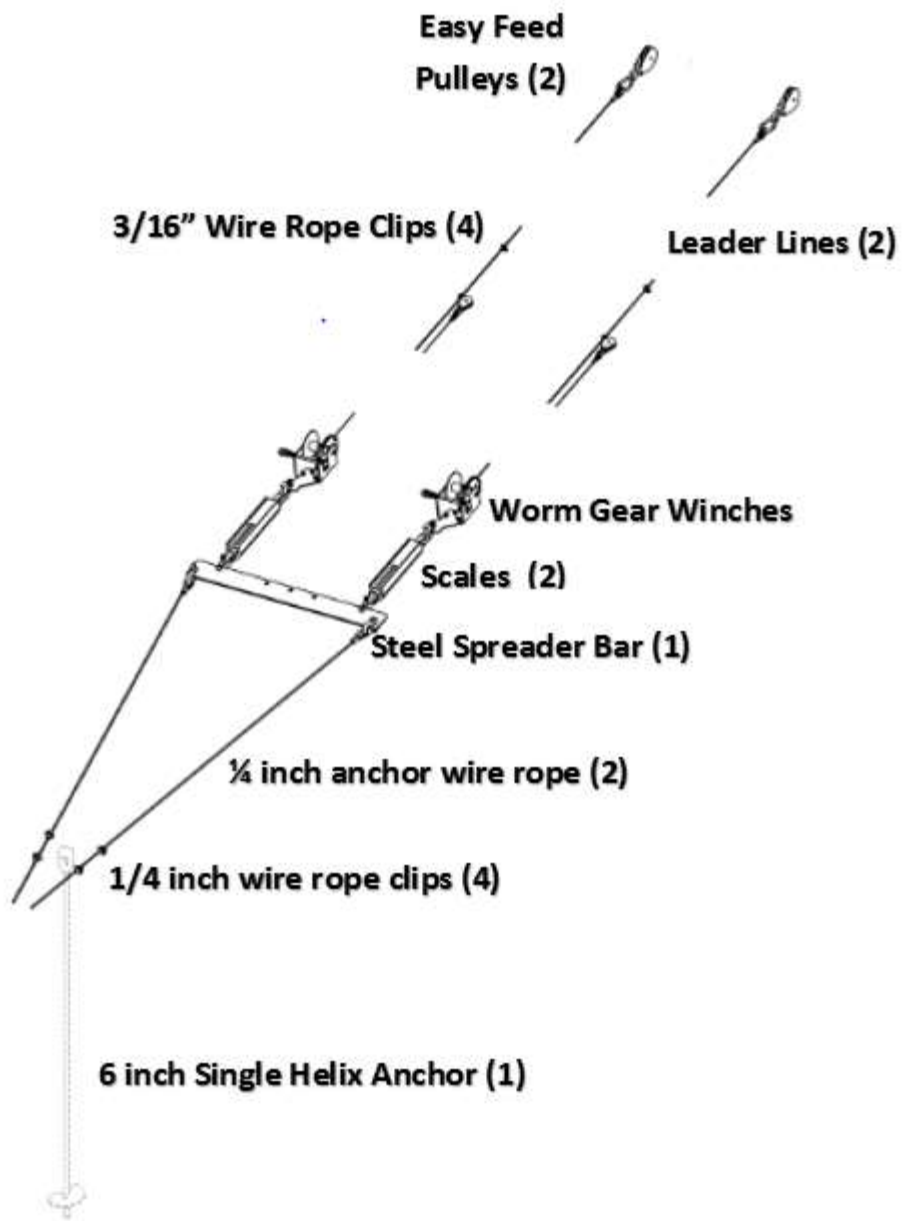

Picture R-7: Connecting the worm gear winch cables to the leader lines



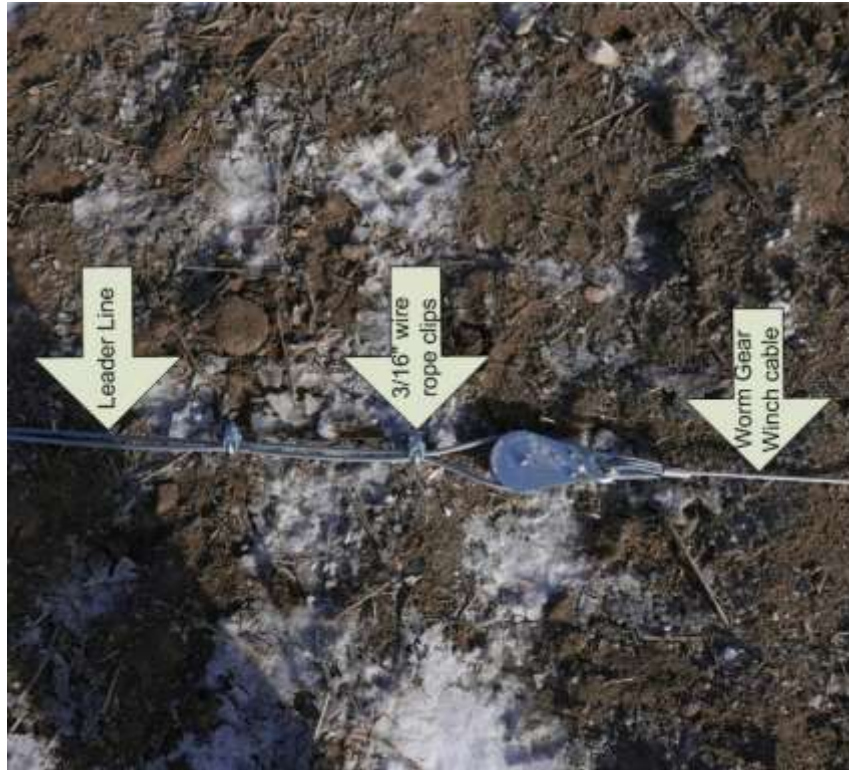

**Picture R-8: Connecting the worm gear winch cables to the leader lines**

### **R.4.3 Lift-Cycle Instructions**

Once the leader lines are connected to the worm gear winches, prepare to raise the tower following the Lift Cycle procedure:

- Set the initial tensions on the worm gear winches to the loads shown in Table R-2 and indicated on the load scales. As a goal, aim to have the forces within  $\pm 10$  lbf of the target listed in the table.

**Table R-2: Worm Gear Winch Tensions – Start of Lift Cycle**

Back Guywire Level	Worm Gear Tension (lbf) foot pounds
2,3 (Lower)	60
4,5	50

The tensions listed in Table Q-2 are the starting loads in the Lift Cycle. Above 70°, throughout the lifting process, a minimum of 50 lbf shall be applied to the first four back guywire levels at all times.

- When the crew is ready, begin raising the tower. Personnel operating the worm gear winches shall closely monitor the load scales and SIGNAL to STOP the LIFT when the maximum forces have been achieved in any one of the load scales. Pay attention to the load scales as the load increases quickly above 150 lbf. The maximum force at which the lift cycle is stopped is:
  - 200 lbf when the Tower is between 70° to 80°
  - 150 lbf when the Tower is above 80°

- The typical tower movement will be between 0.5° to 2° for each lift cycle.
- A crew member stationed near the back anchor out of the fall zone shall continuously monitor the back guywires to make sure the tension is within acceptable limits.
- After the lift cycle has stopped, reduce the loads (starting with the top of the tower-guy wires 4 & 5) by spooling out the worm gear winch lines so that the forces read by the load scales return to the starting loads listed in Table Q-2. Typical spool out distances will be on the order of 1 foot on leader line 1 (serving back guywire level 1) and extending up to 3 feet on leader line 5 (serving back guywire level 5). *If a lower guy level is spooling out more than 1 foot and the load is not decreasing – STOP. Assess the situation, make sure the tower is in column. Determine the root cause as to why the load is not decreasing with increasing spooling. Correct the cause before proceeding.*
- When both worm gear winch operators signal that they have returned to the starting loads in Table R-2: R-2, the lift cycle is repeated. The lift cycle is repeated throughout the tower lift, beginning when the tower is at 70° and proceeding until the first of the following occurs:
  - The top of the tower is directly over the baseplate (sight with a carpenter’s level or transit – do not guess), OR
  - Back guywire becomes tight before the tower is vertical
    - During the tower lift, depending on the available lengths of the back guywires, one or more back guywires may become tight. The distance between the Easy-Feed pulleys and the tower itself should be **greater than** ten (10) tower tube diameters. As shown in Picture R-10 (**referencing an 80 m XHD tower for example**), back guywire #5 and #8 are too tight – the Easy-Feed pulley on back guywire #5 is approximately three (3) diameters from the tower column; the Easy-Feed pulley on back guywire #8 is approximately eight (8) tower diameters from the tower column. In both cases, these back guywires are too tight and the tower lift should have been stopped when the Easy Feed pulleys were ten (10) tower diameters from the tower column. In Picture R-10, back guywires #4 and #6 are at acceptable tensions. Picture R -11 shows a tower installation in which all of the back guywires tensions have acceptable tension.

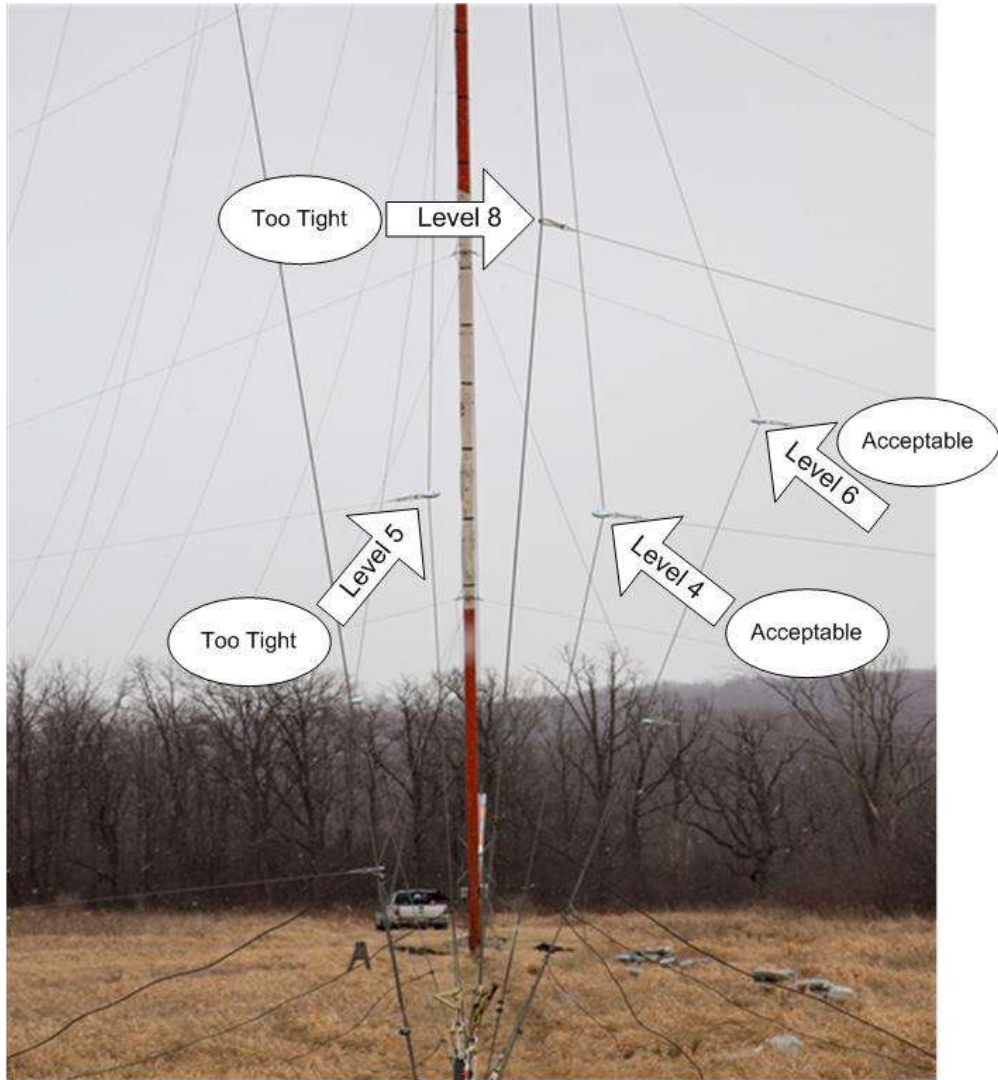

**Picture R-10: View of an 80 m XHD tower showing acceptable and unacceptable back guywires/leader line tensions. Only 4 lines will be seen with a 60m XHD tower.**

- Should the back guywires become tight, personnel monitoring the back guywire tension will signal to STOP the lift. Adjust the back guywire tension using the methods prescribed in [4.2.2 Adjusting Guy Wires \(The “Inchworm” Method\)](#) of the Manual. Proceed with the lift using the back guywire tensioners until the tower is directly over the baseplate.
- Check that wire rope clips on the back and side guy wires are secure.

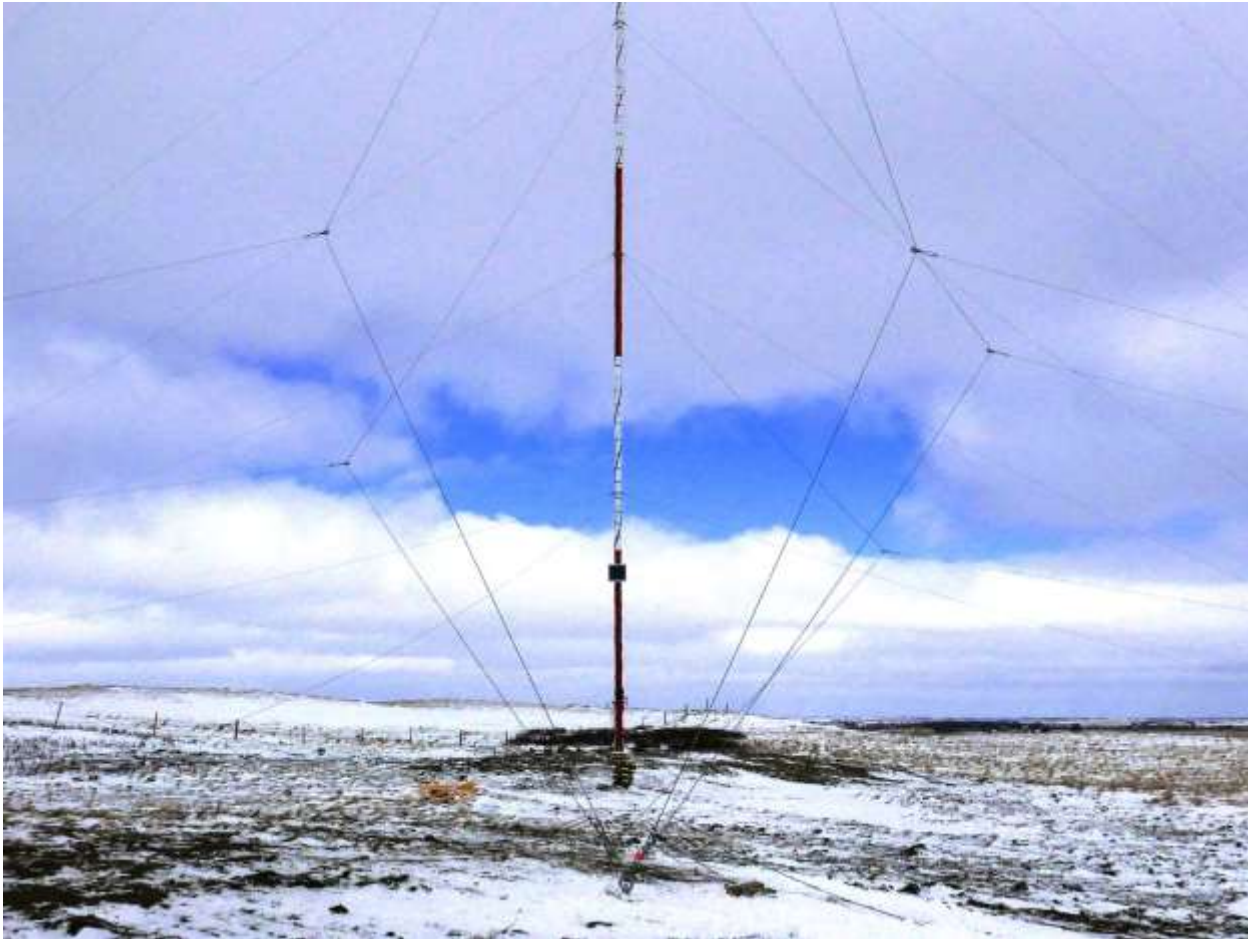

**Picture R-11: View along tower showing acceptable back guywire/leader line tensions**

#### ***R.4.4 Attach the Front Guys***

The back guywire tensioner is very useful during the transfer and attachment of the front guywires since it provides constant tension to the back guywires throughout the transfer process.

Once the tower is directly over the baseplate, the lift is stopped. Confirm that all side guy wire tension is satisfactory.

Set all 4 load scales to 100 lbf  $\pm$  10 lbf using the worm gear winches. Now, one-by-one, transfer the front guywires from the ginpole rocker plate to their respective anchors, starting with front guywire #6 (top level) and working down the tower. Each front guywire is tensioned manually at this point. Once all 6 front guy wires have been transferred to their respective anchor, the 2 technicians that monitor the worm gear system can return to their stations. The crew leader can now work on plumbing the tower

#### ***R.4.5 Plumb and Straighten Tower***

The back guywire tensioner provides constant tension to the back guywires during the tower plumbing and straightening process.



Prior to plumbing and straightening the tower, set all load scales to 100 lbf  $\pm$  10 lbf. Personnel stationed at the back guywire tensioners shall monitor and maintain this tension on all load scales during the plumbing and straightening process.

Make sure any kinks in the tower are eliminated by tightening or loosening the relevant guywires. Once kinks have been removed, proceed to plumb and straighten the tower. Using a carpenter or digital level, measure the verticality of the base tube. Adjust the lower level guy wires as needed until the base tube is vertical ( $90^\circ \pm 0.5^\circ$ ).

It may take multiple adjustments from the bottom to the top of the tower before the tower is completely plumb. Starting with level 1 and working your way up the tower, have 2-3 technicians working at the front anchors to tension the guy wires. First set level #1 back guy tension to 50 lbf using the worm gear, then pull in on the front guy wire to straighten the tower. As level 1 front guy wire is being tensioned, the scale measuring the back guy wire for level 1 will increase. Slowly feather the worm gear on the back guy wire to remain at 50 lbf while the front guy wire is tensioned.

Once you achieve the desired tower location for level one, lock down the front guy wire at the anchor point with the correct wire rope clips and re-tension the scale on the back guy wire to 100lbf. Move to level 2 and repeat the same process. It may be necessary to skip guy levels and work on a particular level that is too far out of alignment. You should always try to keep the tower as straight as possible while plumbing the tower. You will notice that the levels above the one you are working on will increase their tension as you plumb the tower. Keep tensions at 150 lbf or below if they try to spike to higher tensions.

When the tower is plumb, set up on the back anchors. One level at a time, pull in the slack on the back guy wire while letting out on the worm gear, until the easy feed pulley is no longer holding the back guy wire. Remove pulley and fasten guy wire to anchor at the correct pulse method tension shown in [Table 4-2](#).

When the tower is plumb, all guywires shall be properly tensioned mechanically and tested using the pulse method for guy tension. See manual for proper pulse method guy tensions.

## **R.5 Lowering the tower**

Opposite procedure would be performed. Tension all 4 back guy wires to the maximum tension (150 lbf between  $90^\circ$  and  $80^\circ$ ). Lowering the tower until the minimum tension is achieved based on [Table R-1](#) above. Then re-tension all 4 lines to maximum tension again. From  $80^\circ$  to  $70^\circ$  the maximum tension is 200lbf. Once the tower is lowered down to  $70^\circ$  back tensioners are no longer needed. Side guy wire tension, on the other hand, needs to be monitored throughout the entire lowering process.

## Appendix S: Utilizing the NRG Systems 80m XHD winch and HPU to raise a 60m XHD tower.

This appendix will explain the set-up and procedure of safely using the NRG Systems 80m winch to raise the 60m XHD tower. Some NRG 80m qualified installer's already own the recommended Bloom winch and Fosters Motors HPU. It is now an accepted practice to use this winch set-up if desired to raise the 60m XHD TallTower.

### R.1 Winch Equipment

The NRG Systems supplied winch kit (NRG Kit # 4915) consists of the following equipment:

- Bloom Manufacturing Inc. Winch Model LS10H-6.2T-XL14-20-5884
- Drum spooled with 228.6 m (750 feet) of 3/8 inch diameter wire rope (per Federal Spec RR-W-410F)
- Winch support plate [to mount to 51 mm (2 inch) receiver hitch]
- Foster Manufacturing Corp. HPU Model 13-1-8GC



**NEVER USE AN NRG SYSTEMS TALLTOWER WINCH FOR THE FIRST TIME TO LOWER A TOWER; ALWAYS USE IT FOR THE FIRST TIME TO RAISE A TOWER. USING AN 80 METER TALLTOWER WINCH FOR THE FIRST TIME TO LOWER A TOWER CAN RESULT IN A DANGEROUS LACK OF WINCH CABLE TENSION WHICH COULD LEAD TO ENTANGLEMENT OR BREAKAGE AND SERIOUS INJURY OR DEATH COULD OCCUR. USING THE WINCH FOR THE FIRST TIME TO RAISE A TOWER CREATES PROPER WINCH CABLE TENSION FOR SUBSEQUENT USES.**

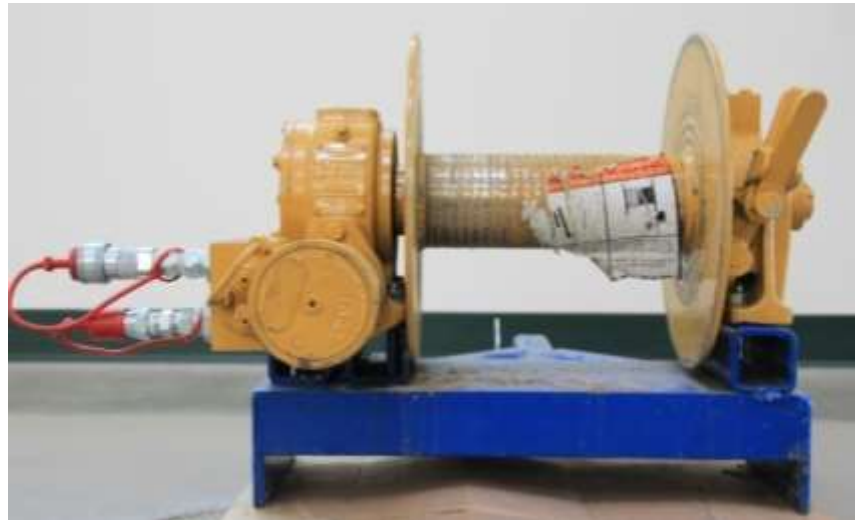

Picture S-2: 80 Meter Bloom winch with mounting plate



**Picture S-3: Foster Manufacturing Corp. HPU Model 13-1-8GC**

## NOTICE

Use only NRG Systems approved lifting devices when raising or lowering NRG Systems TallTowers. NRG approved lifting devices have been carefully designed to provide sufficient line pull strength and safety margin. NRG does not support the use of a substitute winch. Please contact NRG Technical Services for additional information.





A recommended set-up for the winch equipment is shown in picture S-4 below.

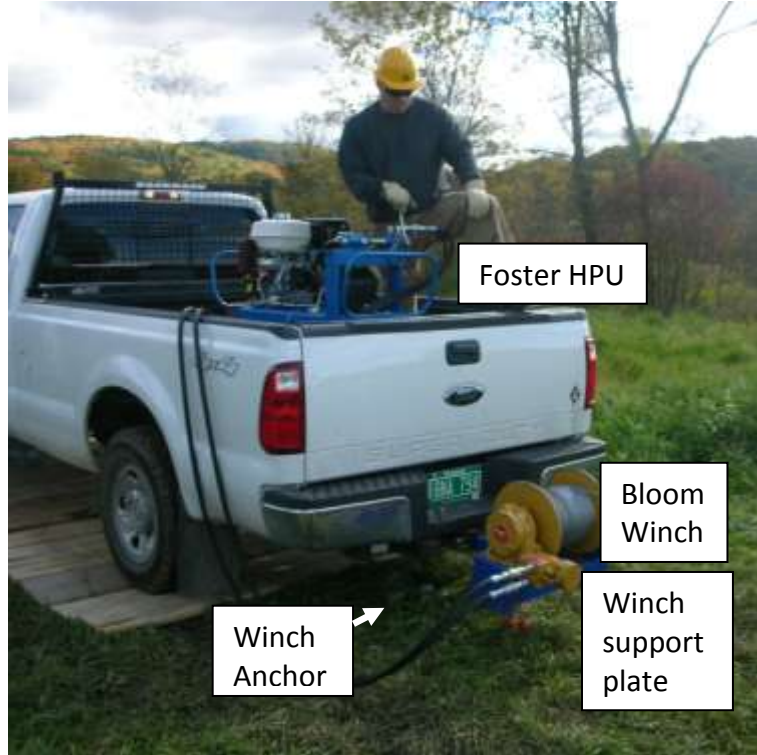

**Picture S-4: Winch set-up**

Verify that the fleet angle – the angle between the winch and the first turning block is less than  $3^\circ$ . Setting the fleet angle to less than  $3^\circ$  (straight as possible) will aid in the proper level winding of the winch cable on the drum. An example of a proper fleet angle is shown below.



**Picture S-5: Correct winch cable fleet angle**

## **S.2 Anchor the winch**

Secure the winch support plate using a sling [with a minimum working load limit of 26.7 kN (6000 lbf)].

**NOTE:** Even though the winch and support plate are mounted to a vehicle, it is imperative the winch assembly be secured to the winch anchor.

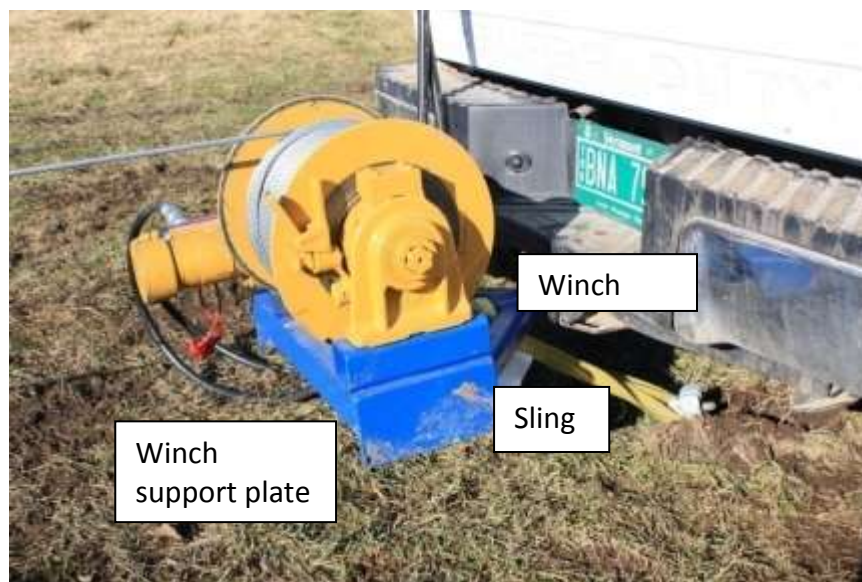

**Picture S-6: Correct winch assembly attached to winch anchor**



**ALWAYS SECURE THE WINCH TO A WINCH ANCHOR. FAILURE TO USE A WINCH ANCHOR COULD CAUSE EXCESSIVE LOADS ON THE VEHICLE USED TO SUPPORT THE WINCH AND WINCH PLATE. EXCESSIVE LOADS CAN RESULT IN THE VEHICLE BEING HOISTED IN THE AIR CAUSING SERIOUS INJURY OR DEATH OR PROPERTY DAMAGE. NEVER RELY ON AN UNSECURED WINCH AND SUPPORT PLATE – ALWAYS USE A WINCH ANCHOR.**

### **S.3 Assemble the Bridle Cable and Pulley's**

Attach one end of each bridle cable to each bridle cable anchor using the supplied shackle. Attach the other ends of the bridle cables to the supplied shackle and attach the shackle to the supplied bridle anchor pulley. See picture S-7 below.



**Picture R-7: Bridle cable assembly**





**Picture S-8: Bridle cable assembly with extra block pulley for use with 80m winch**

#### **S.4 Set-up (Reeve) the Winch Cable**

Run the HPU to power the winch so that the cable can be un-spooled. **The cable must un-spool from the top of the cable drum in order for the brake to function properly.** Pull out the winch cable and route as listed:

1. Through the first block pulley between the winch and the bridle anchor pulley.
2. Over one of the helper ginpole sheaves.
3. Through the turning block at the top of the main ginpole.
4. Over another helper ginpole sheaves.
5. Through the turning block at the bridle cables (in front of the winch).
6. Over the top of the helper ginpole sheaves.
7. Ending at the top of the main ginpole.

**Note:** To open the supplied pulleys, remove the pin from one side of the pulley.

**Note:** When putting the winch cable over the top of the helper gin pole, it does not matter which cable goes in which helper ginpole sheave. It is also not necessary to center the helper ginpole pulleys.

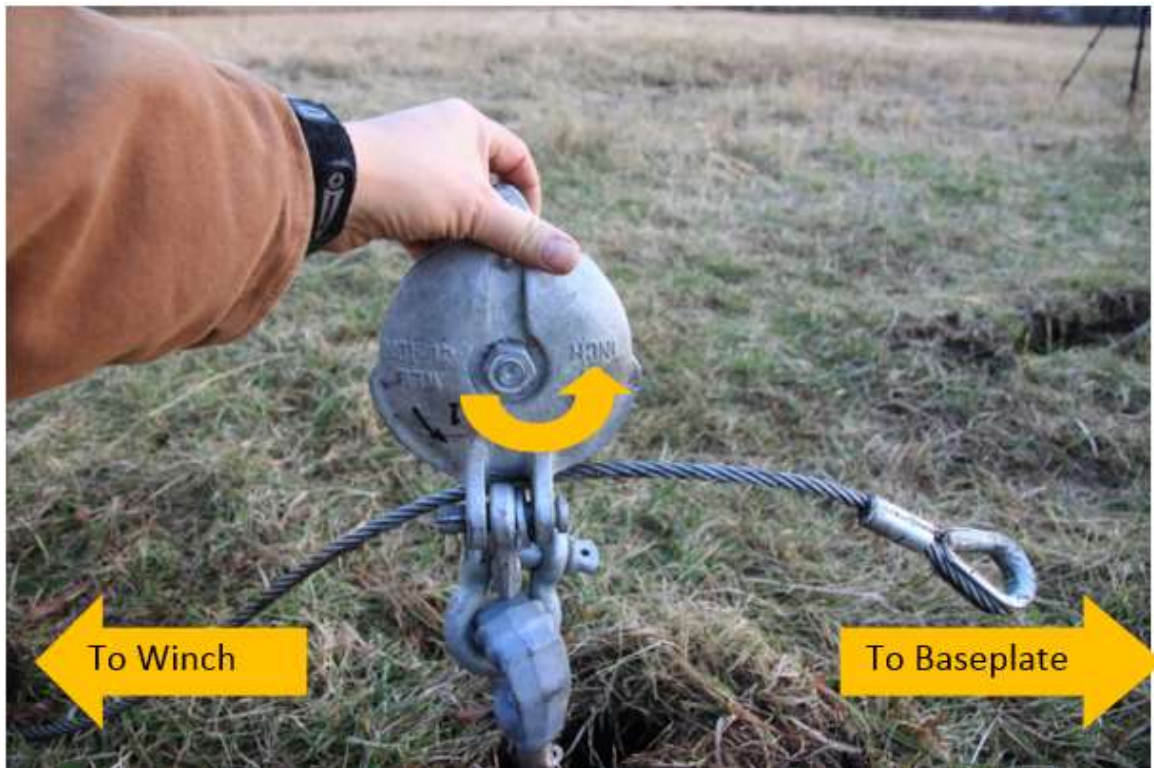

**Picture S-9: Extra Block Pulley installed where standard 60m XHD winch is anchored**

Continue to follow the procedure in the manual starting at [3.10.1 Secure Winch Cable to Top of Ginpole](#).

## Index

“Inchworm” method.....	48
10 m .....	140, 142, 143
40 m .....	12
40 m HD .....	12
50 m .....	12
50 m HD .....	12
50m XHD TallTower Painted Version.....	168
60 m .....	12
60m XHD TallTower Painted Version.....	167
alternative anchoring.....	135
anchor placement.....	19, 136
anchor radii.....	18
anchor requirements .....	131
anchoring ..12, 18, 19, 54, 56, 131, 134, 135, 136, 137, 138, 140, 145, 147	
Anchoring Guidelines.....	131
anchoring in solid rock.....	135
anchoring the baseplate .....	24, 25
anchors13, 18, 19, 20, 26, 63, 131, 132, 133, 134, 135, 136, 137	
Anchors .....	18
ANSYS Finite Element Analysis.....	141
arrowhead anchors.....	134, 136
arrowhead anchors, installing .....	137
arrowhead anchors, pre-tensioning .....	137
base plate.....	11, 13, 18, 19, 20
base tube .....	29
baseplate .11, 18, 19, 20, 21, 22, 24, 26, 29, 37, 40, 52	
batteries.....	147
boom, mounting .....	169
building codes .....	140
cement grout .....	138
concrete anchors .....	131
coupler plates .....	39, 44
doublers .....	24
drive rod.....	134
EIA-222-F.....	140, 142, 143, 144
EIA-222-F requirements.....	66
electrical tape .....	31
EnviroCrate .....	13, 14, 15, 17
FAA Height Compliance .....	128
gin pole assembly .....	37
Ginpole compatibility.....	139
ginpole ropes .....	45
Ginpole Tilt-Up.....	46
glossary .....	148
gussets.....	22, 24
guy guards .....	62
guy ring corners .....	29
guy rings .....	26, 29, 34, 35, 37, 46
guy wire tensioning.....	47
guy wires .....	34
guys ....19, 53, 56, 57, 63, 135, 136, 137, 138, 145, 146	
Hankmaster .....	13, 35, 36, 153, 164, 165, 166
helper ginpole .....	37, 40, 43, 46, 65
ice loading .....	144
icing.....	63, 131, 147
installing arrowhead anchors.....	136
installing rock anchors .....	138
lifter transfer hoist .....	54, 56, 65
lifter wires .....	37, 39
lifters .....	34, 37, 46, 51, 54, 56
Lightning Protection.....	128
lightning rod .....	31
lightning spike .....	31
loads.....	135, 142, 144
oil on tower joints .....	29
Painted 60 m XHD .....	167
pivot pipe .....	29, 37, 155
pre-lift .....	31
pre-tensioning arrowhead anchors.....	137
quick release pin .....	29
rock anchors.....	135
rock anchors, installing .....	138
safety.....	6
<b>safety cable</b> .....	37, 38, 39, 151
screw-in anchors, installing.....	136
screws, self-drilling.....	30
sensor cables.....	33
settling.....	63
shackles .....	35, 42, 46
Side mount booms .....	169
Site Layout.....	17
site visit procedures .....	147
site-built anchors .....	131
slack in guy wires .....	53, 136, 137, 138, 146, 147
soil .....	12, 131, 133, 134, 135, 136, 137
soil type.....	131
standard footprint configuration .....	47, 66, 81, 115
straightening the tower .....	57
stretch, guy wires.....	63
structural analysis .....	140



TallTower installation on a slope .....	19	winch .11, 12, 13, 18, 20, 24, 39, 41, 42, 43, 44, 51, 52,	
tension, guy wire .20, 47, 53, 54, 56, 57, 137, 145, 146		53, 54, 56, 65, 78, 90, 101, 112, 125, 137, 139, 152	
tools .....	12	winch anchor.....	18
Tower Lowering .....	65	winch compatibility.....	139
transferring the lifting guys .....	54	winch control bar .....	41
transition tube .....	26	wind force .....	142, 143, 144
tube layout.....	26	wind vane alignment.....	159
unpacking.....	10, 13	wire rope clips.....	13, 36, 48, 49, 53, 54, 62
WARNINGS.....	6		